



A complete, versatile system of modular containers, perfectly integrable in the SYSTEM domestic range and able to meet the high protection installation requirements of the residential, commercial and industrial sectors. The 27 COMBI range is available both in the IP40 version and in watertight versions with IP55, IP65 and IP66 degree of protection, recommended for all outdoor applications which are subjected to extreme atmospheric conditions.

Description	4 modules	Colour	Toner black
Colour Plate	Black	Door type	With membrane
Door colour	Transparent	For flush mounting box	GW24404, GW24404PM
IP degree	IP55	Insulation class	II
Mechanical resistance	IK07	Glow Wire Test	650 °C
Thermo-pressure with ball	70 °C	Standard	EN 60669-1
Installation temperature	-25 +60 °C	Electrocod	0110

BEHAVIOUR WITH CHEMICAL AND ATMOSPHERIC AGENTS

Saline solution	Acids		Bases		Solvents				Mineral oil	UV rays
	Concentrated	Diluted	Concentrated	Diluted	Hexane	Benzol	Acetone	Alcohol		
Resistant	Limited resistance	Resistant	Resistant	Resistant	Limited resistance	Not resistant	Not resistant	Not resistant	Limited resistance	Resistant

DIMENSIONAL

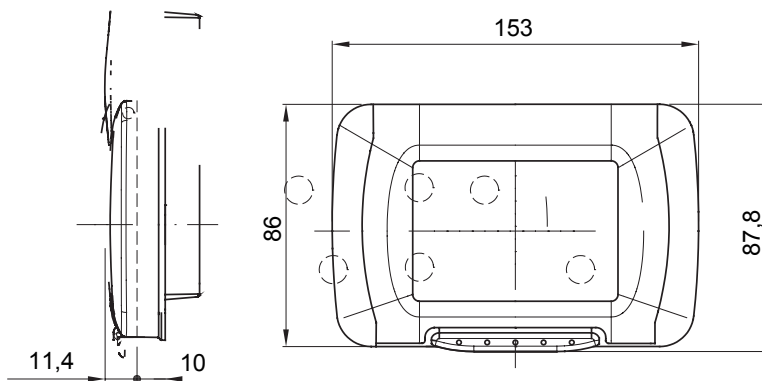

TECHNICAL SYMBOLOGY

IP

IP55



II

IK

IK07

GWT

650 °C



70 °C

STANDARDS/APPROVALS

