



Beschreibung Interruttore non automatico scatolato

Artikelnr. MSXM 1250

Anz. Pole 3P

Bemessungs- strom 1250 A

Auslöser -

#### ELECTRICAL CHARACTERISTICS

Norm	IEC/EN 60947-2	Ausführung	Fest
Kategorie	AC-23A, DC-22A	DIN rail mounting	Nein
Bemessungs- frequenz (Hz)	50 / 60	Accessoriabile con comando motore	Si
Rated operating voltage (Ue)	690 Vac - 250 Vdc	Compatible interlock	-
Bemessungsstoß- spannungsfestigkeit (Uimp)	8 kV	Terminals supplied	Rückseitige RC
Überspannungs- kategorie	IV	Position Montage	Jeder
Isolationsspannung (Ui)	800 V	Upline/downline power supply	Si
Thermal regulation	-	Electrical life (415Vac)	4.000 cycles
Magnetic regulation	-	Mechanical life	5.000 cycles
Neutral protection	-	Betriebstemperatur	-5°C +65°C
Total power loss	210.93 W	Lagertemperatur	-20° +65°
Rated short-circuit current making capacity (Icm)	32	Gewicht (kg)	18.2
Rated short-time withstand current for 0,3s (Icw)	15 kA	Breite	210 mm
I <sub>dn</sub> regulation	-	Höhe	370 mm
DT regulation	-	Tiefe	120 mm

#### SERVICE BREAKING CAPACITY (ICU)

220/240Vac	-	220/240Vac	-
400/415Vac	-	400/415Vac	-
440Vac	-	440Vac	-
525Vac	-	525Vac	-
690Vac	-	690Vac	-
250Vdc	-	250Vdc	-

### Abmessungen

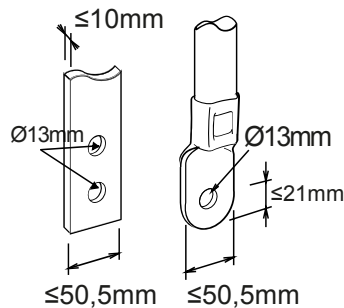



Produktdatenblatt

GWD9459

Baureihe MSX

Normen / Richtlinien

