



Beschreibung Interruttore automatico scatolato

Artikelnr. MSXE 1600

Anz. Pole 4P

Bemessungs- strom 1600 A

Auslöser elektronisch

ELECTRICAL CHARACTERISTICS

Norm	IEC/EN 60947-2	Ausführung	Fest
Kategorie	B	DIN rail mounting	Nein
Bemessungs- frequenz (Hz)	50 / 60	Accessoriabile con comando motore	Si
Rated operating voltage (Ue)	690 Vac	Compatible interlock	A filo (meccanismo in dotazione)
Bemessungsstoß- spannungsfestigkeit (Uimp)	8 kV	Terminals supplied	Verlängerte vorderseitige FB
Überspannungs- kategorie	IV	Position Montage	Jeder
Isolationsspannung (Ui)	800 V	Upline/downline power supply	Si
Thermal regulation	0,4 - 0,5 - 0,63 - 0,8 - 0,9 - 0,95 - 1 x In	Electrical life (415Vac)	2.000 cycles
Magnetic regulation	Electronic LSI	Mechanical life	5.000 cycles
Neutral protection	50% - 100% x Ir	Betriebstemperatur	-5°C +65°C
Total power loss	225.28 W	Lagertemperatur	-20° +65°
Rated short-circuit current making capacity (Icm)	-	Gewicht (kg)	35
Rated short-time withstand current for 0,3s (Icw)	20 kA	Breite	280 mm
I _{dn} regulation	-	Höhe	370 mm
DT regulation	-	Tiefe	140 mm

SERVICE BREAKING CAPACITY (ICU)

220/240Vac	85 kA	220/240Vac	65 kA
400/415Vac	50 kA	400/415Vac	38 kA
440Vac	45 kA	440Vac	34 kA
525Vac	30 kA	525Vac	23 kA
690Vac	20 kA	690Vac	15 kA
250Vdc	-	250Vdc	-

Abmessungen

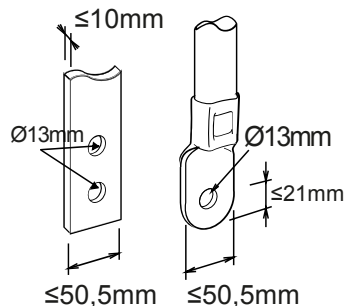



Produktdatenblatt

GWD9425B

Baureihe MSX

Normen / Richtlinien

