

The System modular devices make it possible to create infinite combination between devices and plates, thanks to a complete range that is able to satisfy all design, functional and installation requirements. Colour and finiture: glossy white, bright and versatile
Ideal for flush-mounting solutions (for rectangular or square boxes), surface-mounting solutions, and for special applications. The range includes commands, socket- outlets, protection, indicators, connectors and devices for the control, safety and comfort of your home.

Beschreibung	2P+E - 15A	Farbe	Weiss
Spannung	250 V ac	Schutzleiter- anschluss	-
Standard	Australisch	Merkmale	-
Für Steckstifte	Flach	Norm	IEC 60884-1; AS/NZS 3112
Widerstand bei Prüfspannung	2000 V bei 50 Hz für 1 Minute	Anzahl Betätigungen (Änderung Schaltstellung).	10.000 bei In 250 V ac cosφ=0,8
Kugeldruckprüfung	125 °C	Glühdrahtprüfung	850 °C
Haltekraft Klemme	> 50 N	Anschluss feindrätig (mm²)	min. 0,75 - max. 2x4
Anschluss massiv (mm²)	min. 0,5 - max. 2x2,5	Anz. SYSTEM Module	2
Material	Technopolymer	Electrocod	0131

Abmessungen

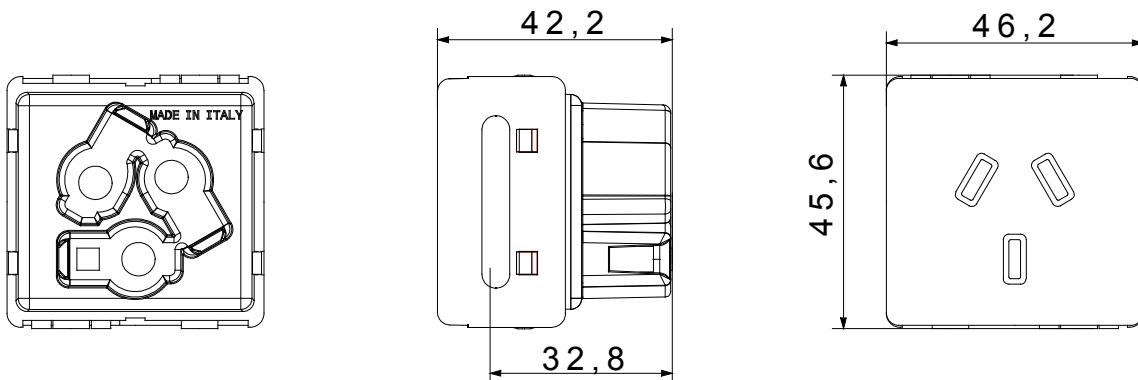

Technische Symbole



Normen / Richtlinien

