

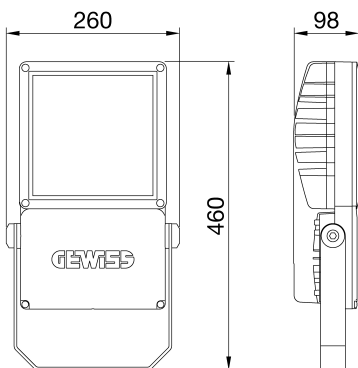

SMART [PRO]e 1M is a medium-power outdoor and indoor LED floodlight, ideal for lighting small to medium-sized areas and sports facilities. It can be installed on the wall, ceiling or ground thanks to the galvanised steel bracket which is powder coated in polyester with trivalent passivation and equipped with an adjustable goniometric scale and supplied in kit form. The main body is made in die cast aluminium EN AB 46100, with an integrated passive heat sink, and powder coated polyester frame with trivalent passivation. COB LED technology for high efficacy. Reflector made of metallised PC-HT or anodised and polished aluminium. 4mm thick toughened front glass, silkscreen printed for symmetrical versions or with anti-reflective nanocoating for asymmetrical versions. Anti-ageing silicone gaskets and A2 stainless steel exterior screws. Plastic venting and anti-condensation device. Electrical connection via 5x1mm² H07RN-F cable. Insulation Class 1. Built-in 1-10V dimmable driver. Available with five different types of optics, three types of Correlated Colour Temperature (3000K/4000K/5700K) and two different types of Colour Rendering Index (CRI70, CRI80). Designed to withstand surges up to 6KV (differential mode) and 10KV (common mode), temperature variations from -30°C to +40°C, water and dust penetration up to IP66, and impact up to IK08.

GENERAL INFORMATION		OPTIC AND ILLUMINATING FEATURES	
Context	Floodlighting and small- to medium-size sports facilities	Optic	SM - Symmetrical Medium
Luminaire	LED luminaire with mid lumen power	Unified Glare Rating	G*6 - ULOR = 0%
Application	Indoor / Outdoor	Lumen output (lm)	21900
Unique digital code (Datamatrix)	Currently not present	Efficacy (lm/W)	146
Colour	Graphite grey	Colour temperature	3000 K
Type of light source	LED - Not replaceable	Colour Rendering Index	CRI>70
System power	150 W	Standard Deviation Colour Matching	SDCM = 3
LED Lifetime	L90B10 (Tq+25°C) = 100000h; L80B10 (Tq+25°C) > 150000h	Photobiological Risk Class	RG1
Weight (kg)	5.7	Standard	EN60598-1; EN60598-2-5; IEC62778; EN13201
Warranty	5 years	ELECTRICAL AND LIGHTING FEATURES	
Stocking temperature	-	Supply voltage	220 - 240 V
Operating temperature	-30 +40 °C	Rated frequency (Hz)	50 / 60
MATERIALS		Driver	Included
Body	Die-cast aluminium	Driver failure rate	F10 = 100.000h Tq25°C
Shield type	Flat tempered glass 4mm	Overvoltage protection	DM 6 kV / CM 10 kV
Optic	Metallised PC-HT Reflector	Control System	Stand Alone - 1/10V
Gasket	Anti-ageing silicone	INSTALLATION AND MAINTENANCE	
Locking Hook	-	Mounting and installation	High-mast lighting - Wall mounting - Ground mounting
External screw	Stainless steel	Tilt	Rotation on bracket with integrated goniometer
Colour	Polyester powder coated with epoxy base coat	Wiring	With H07RN-F multi-pole cable
STANDARDS AND APPROVALS		Fixing	Bracket
Classification	-	Light source replaceability	By professional
Device with reduced surface temperature	-	Controlgear replaceability	-
DIN 18032-3 certification	Compliant	Driver Box	Built-in
IPEA	-	Maximum surface exposed to the wind	0,085 m ²
Insulation class	I	-	-
IP degree	IP66	-	-
Mechanical resistance	IK08	-	-

DIMENSIONAL



PHOTOMETRIC DISTRIBUTION

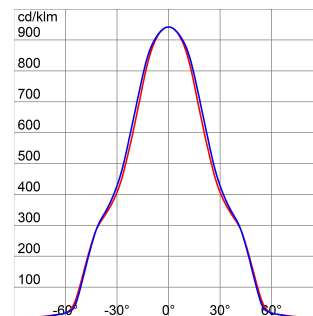

Smart [PRO]e

TECHNICAL SYMBOLOGY



IP
IP66

IK
IK08

STANDARDS/APPROVALS

