



High-power LED streetlight with cover, frame, and pole attachment in EN AB 46100 die-cast aluminium with low copper content, with polyester powder coating. Suitable for installation both on top of the pole and offset, with 5° pitch adjustment. Opening and closing system with integrated front handle. Closure fabricated in tempered flat glass (thickness 4 mm). Cable input via PG13.5. Safety switch. Cable plate in PA6.6+PV. Printed Circuit Board (PCB) in metal core. Metallic PC optic system. Common mode surge protection up to 10 kV. Operational up to 50°C ambient temperature but with reduction of the supply current as indicated in the Instruction Manual.

GENERAL INFORMATION

Context	Street and parking lighting
Luminaire	LED Road Equipment
Application	External
Unique digital code (Datamatrix)	Currently not present

Colour	Graphite grey
Type of light source	LED
System power	51 W @ 0,7A
LED Lifetime	L90B10(Tq25°C)>115.000h; L90B10 (Tq50°C)=115.000h
Weight (kg)	6.6
Warranty	5 years
Stocking temperature	-
Operating temperature	-25 +50 °C

MATERIALS	
Body	Die-cast aluminium
Shield type	4mm thick flat tempered glass
Optic	Silver PVD aluminium reflector
Gasket	Anti-aging silicone
Locking Hook	Integrated front handle
External screw	Stainless steel

Colour	Powder coating
STANDARDS AND APPROVALS	
Classification	-
Device with reduced surface temperature	-
DIN 18032-3 certification	Not available
IPEA	-
Insulation class	I
IP degree	IP66
Mechanical resistance	IK08
Glow Wire Test	-

OPTIC AND ILLUMINATING FEATURES

Optic	HUGE
Unified Glare Rating	G*4 - ULOR = 0
Lumen output (lm)	6000
Efficacy (lm/W)	118
Colour temperature	3000 K
Colour Rendering Index	CRI>70
Standard Deviation Colour Matching	SDCM = 5
Photobiological Risk Class	RG0

Standard	EN 60598-2-3, EN 60598-1 IEC/TR 62778
ELETRICAL AND LIGHTING FEATURES	
Supply voltage	220 - 240 V
Rated frequency (Hz)	50 / 60
Driver failure rate	F10=100.000h Tq25°C/75.000h Tq50°C
Driver	Included
Overvoltage protection	DM 10KV / CM 10KV
Control System	Stand alone

INSTALLATION AND MAINTENANCE	
Mounting and installation	Pole Head - Outreach
Tilt	-20° + +10° side bracket - -10° + +20° pole head
Wiring	Isolating switch
Fixing	Pole Head - Outreach
Light source replaceability	By professional
Controlgear replaceability	By professional
Driver Box	Built-in
Maximum surface exposed to the wind	0.15 m²

DIMENSIONAL

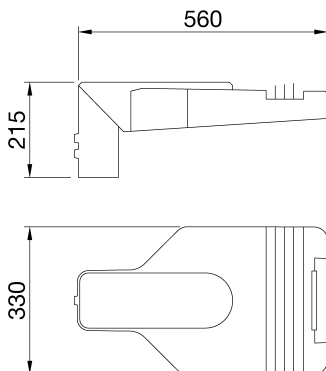

PHOTOMETRIC DISTRIBUTION

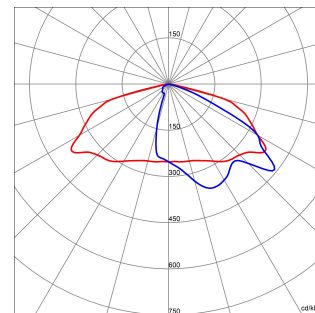

TECHNICAL SYMBOLOGY



IP
IP66

IK
IK08

GWT
-



Product Data Sheet

GWR567230K

ROAD [5] Range

STANDARDS/APPROVALS

