

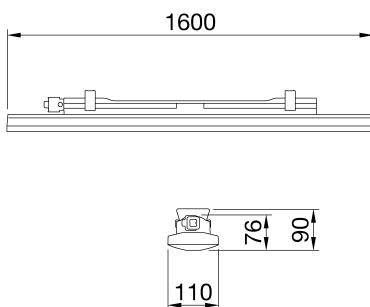

Smart [3] Plus is an IP66/69 ceiling light with LED Flip Type without wire boring, available in 3000K, 4000K, 5700K, with CRI ≥80 and ≥90. IK08 body in self-extinguishing polycarbonate RAL7035, for industrial applications and ideal for production areas, warehouses, and logistics areas. Can replace high flux and lowbay fluorescent devices up to 10,000lm. Available in sizes 800, 1200, 1600mm, powers from 25W to 63W, flows from 4,000lm to 10,000lm, with integrated On/Off or DALI power and 3 different optical solutions, Transparent, Opal and Transparent screen with medium-beam optics complete with TIR lens made of PMMA. The version with through wiring has pre-wired mechanical and electrical components, with a maximum of 25 devices installed in a continuous row. It is possible to install the suspension and wall appliance, accessories bracket GW with inclination of 30° or 45° on the vertical axis. An emergency kit version is available.

GENERAL INFORMATION		OPTIC AND ILLUMINATING FEATURES	
Context	Lighting of warehouses, indoor parking and industrial production rooms	Optic	Microprismatic transparent
Luminaire	LED fixture for general lighting	Unified Glare Rating	UGR ≤ 25 (4H/4H)
Application	Internal	Lumen output (lm)	5900
Unique digital code (Datamatrix)	Datamatrix	Efficacy (lm/W)	118
Colour	Grey RAL 7035	Colour temperature	4000 K
Type of light source	LED	Colour Rendering Index	CRI>90
System power	50 W	Standard Deviation Colour Matching	SDCM = 3
LED Lifetime	L90B10(Tq25°C)=50.000h; L80B10(Tq25°C)=100.000h; L80B10(Tq50°C)=94.000h	Photobiological Risk Class	RG0
Weight (kg)	3.8	Standard	EN60598-1; IEC 62778; IEC62471
Warranty	5 years	ELECTRICAL AND LIGHTING FEATURES	
Stocking temperature	-25 +80 °C	Supply voltage	220-240 V
Operating temperature	-25 +50 °C	Rated frequency (Hz)	50/60 Hz
MATERIALS		Driver	Included
Body	Polycarbonate	Driver failure rate	F10 = 100.000h Tq25°C
Shield type	UV stabilised polycarbonate	Overvoltage protection	DM 1kV / CM 2kV
Optic	Integrated in the screen	Control System	Through wiring - DALI
Gasket	CNC deposited sealant	INSTALLATION AND MAINTENANCE	
Locking Hook	-	Mounting and installation	Ceiling - Wallmounting - Suspension
External screw	-	Tilt	With fixing bracket
Colour	RAL7035 colored PC paste	Wiring	With GW connect watertight connector
STANDARDS AND APPROVALS		Fixing	Stainless steel support
Classification	-	Light source replaceability	Non-replaceable
Device with reduced surface temperature	Yes	Controlgear replaceability	Non-replaceable
DIN 18032-3 certification	Not available	Driver Box	Built-in
IPEA	-	Maximum surface exposed to the wind	-
Insulation class	II	-	-
IP degree	IP66/IP69	-	-
Mechanical resistance	IK08	-	-
Glow Wire Test	850 °C	-	-

DIMENSIONAL



PHOTOMETRIC DISTRIBUTION

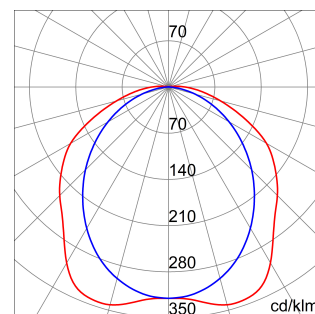

TECHNICAL SYMBOLOGY



IP
IP66/IP69

IK
IK08

GWT
850 °C



Product Data Sheet
GWS3323AT940

SMART [3] PLUS

STANDARDS/APPROVALS

