



Smart [3] is a watertight fixture IP66/69 with Flip Type LED without wire bonding, available in 3000K,4000K,5700K, with CRI ≥80. IK08 body in RAL7035 colored self-exhausting polycarbonate, for industrial applications and ideal for production areas, warehouses, logistics areas and design to replace fluorescent devices and lowbay up to 6,500lm. Available in sizes 800, 1200, 1600mm, powers from 18W to 58W, flux range from 1.700lm to 6.500lm, with integrated Power On/Off or DALI and 2 different optical solutions UV-stabilized self-extinguishing polycarbonate, in opal or transparent finish. The version with passing wiring has mechanical and electrical connection components prewired, with up to 25 fixtures installed in a continuous row. The device can be hung or wall mounted and is available a GW bracket accessories with a tilt of 30° or 45° on the vertical axis. Available also with an emergency kit version.

GENERAL INFORMATION

Context	Lighting of warehouses, indoor parking and industrial production rooms
Luminaire	LED fixture for general lighting
Application	Internal
Unique digital code (Datamatrix)	Datamatrix
Colour	Grey (RAL 7035)
Type of light source	LED
System power	50 W
LED Lifetime	L90B10(Tq25°C)=45.000h; L80B10(Tq25°C)=92.000h; L80B10(Tq50°C)=81.000h
Weight (kg)	2.5
Warranty	5 years
Stocking temperature	-25 +80 °C
Operating temperature	-25 +50 °C
MATERIALS	
Body	Polycarbonate
Shield type	UV stabilised polycarbonate
Optic	Integrated in the screen
Gasket	CNC deposited sealant
Locking Hook	-
External screw	-
Colour	RAL7035 colored PC paste
STANDARDS AND APPROVALS	
Classification	-
Device with reduced surface temperature	Yes
DIN 18032-3 certification	Not available
IPEA	-
Insulation class	II
IP degree	IP66/IP69
Mechanical resistance	IK08
Glow Wire Test	850 °C

OPTIC AND ILLUMINATING FEATURES

Optic	Wide opal
Unified Glare Rating	UGR ≤ 25 (4H/8H)
Lumen output (lm)	6400
Efficacy (lm/W)	128
Colour temperature	4000 K
Colour Rendering Index	CRI>80
Standard Deviation Colour Matching	SDCM = 3
Photobiological Risk Class	RG0

ELECTRICAL AND LIGHTING FEATURES

Standard	EN60598-1; IEC 62778; IEC62471
Supply voltage	220 - 240 V
Rated frequency (Hz)	50/60 Hz
Driver	Included
Driver failure rate	F10 = 100.000h Tq25°C
Overvoltage protection	DM 1kV / CM 2kV
Control System	Through wiring - On/Off

INSTALLATION AND MAINTENANCE

Mounting and installation	Ceiling - Wallmounting - Suspension
Tilt	With fixing bracket
Wiring	With GW connect watertight connector
Fixing	Stainless steel support
Light source replaceability	Non-replaceable
Controlgear replaceability	Non-replaceable
Driver Box	Built-in
Maximum surface exposed to the wind	-

DIMENSIONAL

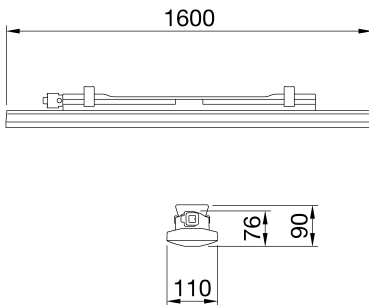

PHOTOMETRIC DISTRIBUTION

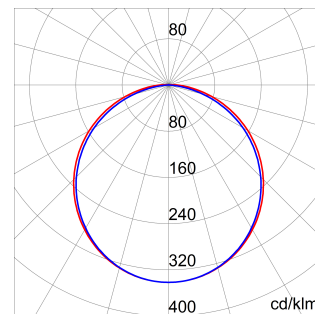

TECHNICAL SYMBOLOGY



IP

IP66/IP69

IK

IK08

GWT

850 °C



Product Data Sheet

GWS3258PL

SMART [3]

STANDARDS/APPROVALS

