



SMART [PRO] 2.0 is a high power outdoor and indoor LED projector, suitable for lighting large areas and sports facilities.

It can be installed on the wall, ceiling or ground thanks to the polyester powder coated galvanised steel bracket with trivalent passivation, equipped with adjustable goniometric scale and supplied in a kit. The body is fabricated in aluminium die casting

EN AB 46100, with integrated passive heat dissipation, powder-coated polyester paint with trivalent passivation. PCB metal core with CSP LED.

Reflector made of metallic HT PC or anodised and polished aluminium. Hardened front glass with 4mm thickness, anti-ageing silicone seals and A2 stainless steel exterior screws. Bracket screws with GEOMET® treatment. Plastic venting and anti-condensation device. Insulation class 1. Remote power supply unit in DALI or DMX options, multiple electrical connection kits, supplied separately.

Available with nine different types of optics, three types of Colour Temperature (3,000/4,000K/5,700K) and three different types of Color Rendering Index (CRI>70, CRI>80, CRI>90).

Designed to withstand surges up to 5KV (RCCB mode) and 10KV (common mode), temperature variations from -30°C to +50°C, water and dust penetration up to IP66 protection grade and shockproof up to IK08 grade.

GENERAL INFORMATION		OPTIC AND ILLUMINATING FEATURES	
Context	Sport, Big Areas	Optic	S1 - Symmetric Wide
Luminaire	LED luminaire with mid and high lumen power	Unified Glare Rating	G*6 - ULOR = 0
Application	Indoor / Outdoor	Lumen output (lm)	109800
Unique digital code (Datamatrix)	Currently not present	Efficacy (lm/W)	113
Colour	Graphite grey	Colour temperature	3000 K
Type of light source	LED	Colour Rendering Index	CRI>70
System power	970 W	Standard Deviation Colour Matching	SDCM = 5
LED Lifetime	L90B10(Tq25°C)=40.000h; L80B10 (Tq25°C)=90.000h	Photobiological Risk Class	-
Weight (kg)	29	Standard	EN60598-1; EN60598-2-5; IEC 62778; IEC 62471; EN13201
Warranty	5 years	ELETRICAL AND LIGHTING FEATURES	
Stocking temperature	-	Supply voltage	-
Operating temperature	-30°C ÷ +50 °C	Rated frequency (Hz)	-
MATERIALS		Driver	To be ordered separately
Body	Die-cast aluminium -	Driver failure rate	See external supply unit
Shield type	Flat tempered glass 4mm	Overvoltage protection	See external supply unit
Optic	Polished quartz and metallized PC HT reflector	Control System	See external supply unit
Gasket	Anti-ageing silicone	INSTALLATION AND MAINTENANCE	
Locking Hook	Hexagonal metric screws	Mounting and installation	High-mast lighting - Wall mounting - Ground mouting
External screw	Stainless steel	Tilt	Rotation on bracket with integrated goniometer
Colour	Polyester powder coated	Wiring	Watertight connector
STANDARDS AND APPROVALS		Fixing	Bracket
Classification	-	Light souce replaceability	By professional
Device with reduced surface temperature	No	Controlgear replaceability	-
DIN 18032-3 certification	Available	Driver Box	External
IPEA	-	Maximum surface exposed to the wind	0,333 m2
Insulation class	I	-	-
IP degree	IP66	-	-
Mechanical resistance	IK08	-	-
Glow Wire Test	-	-	-

DIMENSIONAL

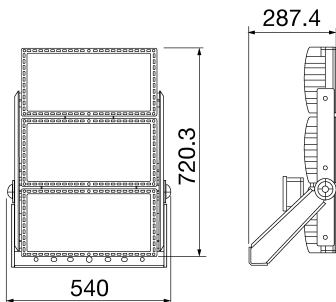

PHOTOMETRIC DISTRIBUTION

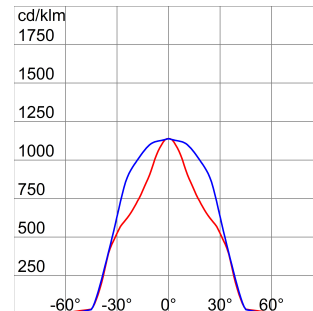

TECHNICAL SYMBOLOGY



IP
IP66

IK
IK08

GWT
-

STANDARDS/APPROVALS

