



SMART [PRO] 2.0 is a medium power outdoor and indoor LED projector, suitable for lighting sports areas and facilities. It can be installed on the wall, ceiling or ground thanks to the polyester powder coated galvanised steel bracket, with trivalent passivation, equipped with adjustable goniometric scale and supplied in kit. The body is produced in aluminium die casting

EN AB 46100, with integrated passive heat sink, powder coated polyester with trivalent passivation. Metal core PCB with CSP LED.

Reflector made of metallic HT PC or anodised and polished aluminium. Hardened front glass with 4mm thickness, anti-ageing silicone seals and A2 stainless steel exterior screws. Plastic venting and anti-condensation device. Electrical connection via IP68 connector for 1.5mm<sup>2</sup> cables. Insulation class 1.

Driver integrated in options 1-10 V or DALI. Available with nine different types of optics, three types of Colour Temperature (3,000K/4,000K/5,700K) and two different types of Chromatic Yield Index (CRI>70, CRI>80). Designed to withstand surges up to 5KV (RCCB mode) and 10KV (common mode), temperature variations from -30°C to +50°C, water and dust penetration up to IP66 protection and impacts up to IK08.

#### GENERAL INFORMATION

Context	Sport, Big Areas
Luminaire	LED luminaire with small, mid and high lumen power
Application	Indoor / Outdoor
Unique digital code (Datamatrix)	Currently not present
Colour	Graphite grey
Type of light source	LED
System power	165 W
LED Lifetime	L90B10(Tq25°C)=50.000h; L80B10 (Tq25°C)=110.000h
Weight (kg)	5.7

Warranty	5 years
Stocking temperature	-
Operating temperature	-30°C ÷ +50 °C

#### MATERIALS

Body	Die-cast aluminium
Shield type	Flat tempered glass 4mm
Optic	Polished anodised aluminum reflector with 99.99% pure aluminum
Gasket	Anti-aging silicone
Locking Hook	Hexagonal metric screws
External screw	Stainless steel

Colour	Polyester powder coated
--------	-------------------------

#### STANDARDS AND APPROVALS

Classification	-
Device with reduced surface temperature	Yes
DIN 18032-3 certification	Available
IPEA	-
Insulation class	I
IP degree	IP66
Mechanical resistance	IK08
Glow Wire Test	-

#### OPTIC AND ILLUMINATING FEATURES

Optic	A3 - Assymetric Narrow
Unified Glare Rating	G*6 - ULOR = 0
Lumen output (lm)	18800
Efficacy (lm/W)	114
Colour temperature	5700 K
Colour Rendering Index	CRI>70
Standard Deviation Colour Matching	SDCM = 5
Photobiological Risk Class	-
Standard	EN60598-1; EN60598-2-5; EN60598-2-24; IEC 62778; IEC62471; EN13201

#### ELETRICAL AND LIGHTING FEATURES

Supply voltage	220 - 240 V
Rated frequency (Hz)	50 / 60
Driver	Included
Driver failure rate	F10 = 100.000h Tq25°C
Overvoltage protection	DM 6 kV / CM 10 kV
Control System	DALI

#### INSTALLATION AND MAINTENANCE

Mounting and installation	High-mast lighting - Wall mounting - Ground mouting
Tilt	Rotation on bracket with integrated goniometer
Wiring	Watertight connector
Fixing	Bracket
Light souce replaceability	By professional
Controlgear replaceability	By professional
Driver Box	Built-in
Maximum surface exposed to the wind	0,085 m <sup>2</sup>

### DIMENSIONAL

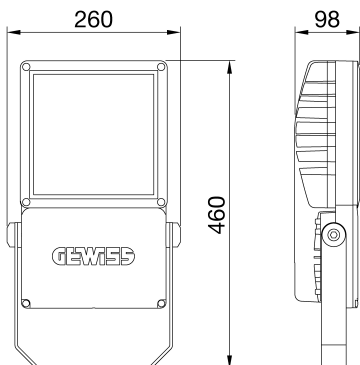

### PHOTOMETRIC DISTRIBUTION

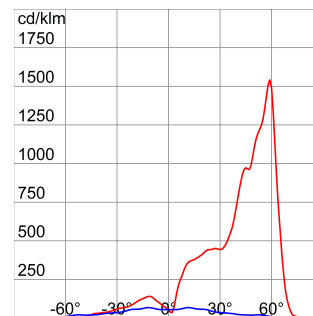



# Product Data Sheet

## GWP2175ND

SMART [PRO] 2.0

### TECHNICAL SYMBOLOGY



  
0,085 m2



**IP**  
IP66

**IK**  
IK08

**GWT**  
-

### STANDARDS/APPROVALS

