



SMART [PRO] 2.0 is a medium power outdoor and indoor LED projector, suitable for lighting sports areas and facilities. It can be installed on the wall, ceiling or ground thanks to the polyester powder coated galvanised steel bracket, with trivalent passivation, equipped with adjustable goniometric scale and supplied in kit. The body is produced in aluminium die casting

EN AB 46100, with integrated passive heat sink, powder coated polyester with trivalent passivation. Metal core PCB with CSP LED.

Reflector made of metallic HT PC or anodised and polished aluminium. Hardened front glass with 4mm thickness, anti-ageing silicone seals and A2 stainless steel exterior screws. Plastic venting and anti-condensation device. Electrical connection via IP68 connector for 1.5mm<sup>2</sup> cables. Insulation class 1.

Driver integrated in options 1-10 V or DALI. Available with nine different types of optics, three types of Colour Temperature (3,000K/4,000K/5,700K) and two different types of Chromatic Yield Index (CRI>70, CRI>80). Designed to withstand surges up to 5KV (RCCB mode) and 10KV (common mode), temperature variations from -30°C to +50°C, water and dust penetration up to IP66 protection and impacts up to IK08.

GENERAL INFORMATION		OPTIC AND ILLUMINATING FEATURES	
Context	Sport, Big Areas	Optic	C1 - Circular 30°
Luminaire	LED luminaire with small, mid and high lumen power	Unified Glare Rating	G*6 - ULOR = 0
Application	Indoor / Outdoor	Lumen output (lm)	20000
Unique digital code (Datamatrix)	Currently not present	Efficacy (lm/W)	121
Colour	Graphite grey	Colour temperature	5700 K
Type of light source	LED	Colour Rendering Index	CRI>70
System power	165 W	Standard Deviation Colour Matching	SDCM = 5
LED Lifetime	L90B10(Tq25°C)=50.000h; L80B10 (Tq25°C)=110.000h	Photobiological Risk Class	-
Weight (kg)	5.7	Standard	EN60598-1; EN60598-2-5; EN60598-2-24; IEC 62778; IEC62471; EN13201
Warranty	5 years	ELECTRICAL AND LIGHTING FEATURES	
Stocking temperature	-	Supply voltage	220 - 240 V
Operating temperature	-30°C ÷ +50 °C	Rated frequency (Hz)	50 / 60
MATERIALS		Driver	Included
Body	Die-cast aluminium	Driver failure rate	F10 = 100.000h Tq25°C
Shield type	Flat tempered glass 4mm	Overvoltage protection	DM 6 kV / CM 10 kV
Optic	Polished quartz and metallized PC HT reflector	Control System	DALI
Gasket	Anti-aging silicone	INSTALLATION AND MAINTENANCE	
Locking Hook	Hexagonal metric screws	Mounting and installation	High-mast lighting - Wall mounting - Ground mouting
External screw	Stainless steel	Tilt	Rotation on bracket with integrated goniometer
Colour	Polyester powder coated	Wiring	Watertight connector
STANDARDS AND APPROVALS		Fixing	Bracket
Classification	-	Light source replaceability	By professional
Device with reduced surface temperature	Yes	Controlgear replaceability	By professional
DIN 18032-3 certification	Available	Driver Box	Built-in
IPEA	-	Maximum surface exposed to the wind	0,085 m2
Insulation class	I		
IP degree	IP66		
Mechanical resistance	IK08		
Glow Wire Test	-		

### DIMENSIONAL

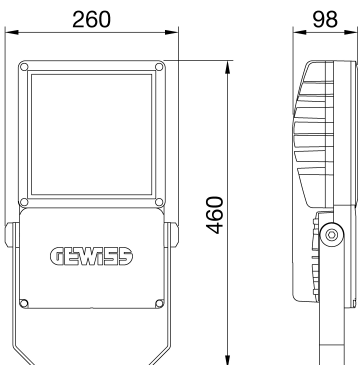

### PHOTOMETRIC DISTRIBUTION

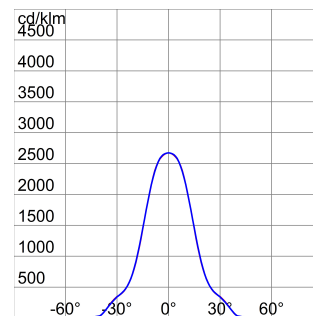



# Product Data Sheet

## GWP2175MD

SMART [PRO] 2.0

### TECHNICAL SYMBOLOGY



  
0,085 m2



**IP**  
IP66

**IK**  
IK08

**GWT**  
-

### STANDARDS/APPROVALS

