

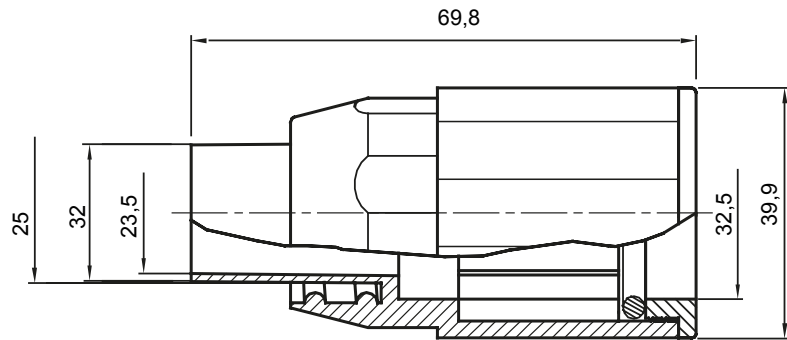

Routing components for rigid protective conduits with IP40 and IP67 protection degree.

Colour	Grey RAL 7035	IP degree	IP65
Conduits Ø (mm)	32	Sheath Ø (mm)	25
Type of material	Halogen-free in compliance with EN 60754-2	Electrocod	21221

### DIMENSIONAL

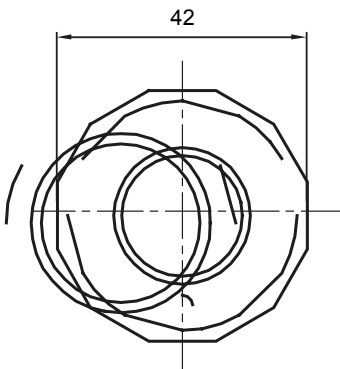

### TECHNICAL SYMBOLOGY

**IP**

**HF**  
HALOGEN FREE

IP65

### STANDARDS/APPROVALS

