

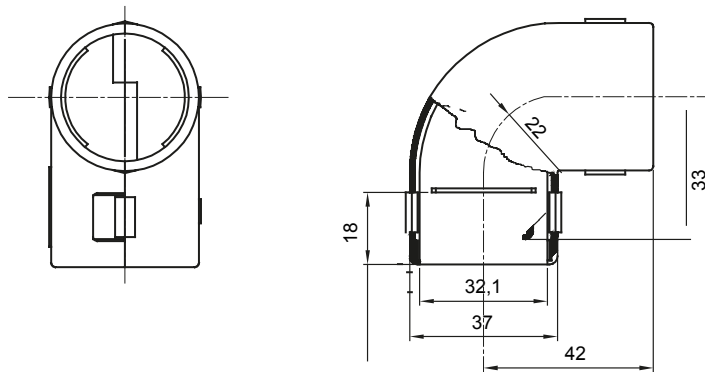

Routing components for rigid protective conduits with IP40 and IP67 protection degree.

Colour	Grey RAL 7035	IP degree	IP40
Conduits Ø (mm)	32	Electrocod	21221

DIMENSIONAL



TECHNICAL SYMBOLOGY

IP

IP40

STANDARDS/APPROVALS

