

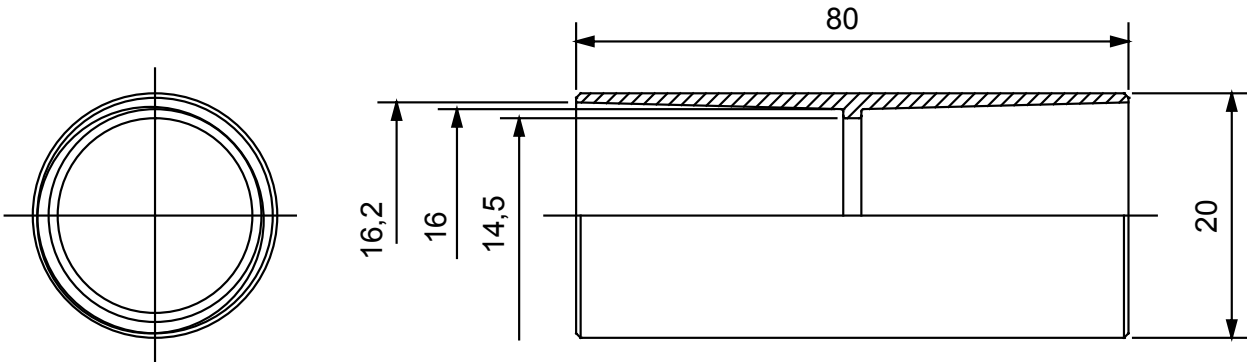

Routing components for rigid protective conduits with IP40 and IP67 protection degree.

Colour	Grey RAL 7035	IP degree	IP40
Conduits Ø (mm)	16	Type of material	Halogen-free in compliance with EN 60754-2
Electrocod	21221		

### DIMENSIONAL



### TECHNICAL SYMBOLOGY



IP40

### STANDARDS/APPROVALS

