



French standard wall mounting enclosure equipped with multipolar terminal blocks. Walls with knock-out elements.

Insulation class	II	Colour	White RAL 9016
Outer dim. LxHxD (mm)	250x350x93.5	IP degree	IP30
Installation	Wall mounting	Mechanical resistance	IK07
No. of modules EN 50022	26 (13x2)	Glow Wire Test	750 °C
Standard	IEC EN 60670-1; IEC EN 60670-24; NF C 61-910	Operating temperature	-25 +60 °C
Electrocod	0321	Thermo-pressure with ball	70 °C
Phase terminal block (mm²)	L(1x35)+(5x25)	Neutral terminal block (mm²)	N(1x35)+(5x25)
Earth terminal block (mm²)	E(4x25)+(24x4)		

BEHAVIOUR WITH CHEMICAL AND ATMOSPHERIC AGENTS

Saline solution	Acids		Bases		Solvents				Mineral oil	UV rays
	Concentrated	Diluted	Concentrated	Diluted	Hexane	Benzol	Acetone	Ethyl alcohol		
Resistant	Not resistant	Limited resistance	Limited resistance	Not resistant	Limited resistance	Not resistant	Not resistant	Limited resistance	Limited resistance	Resistant

DIMENSIONAL

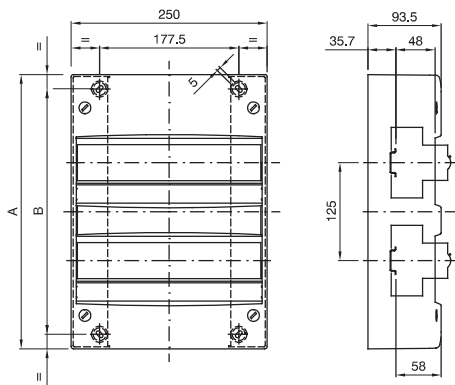

	Codice	A	B
13M	GW 40 501	225	188
26M	GW 40 502	350	313
39M	GW 40 503	475	438
52M	GW 40 504	600	563

TECHNICAL SYMBOLOGY



II

IP

IP30

IK

IK07

GWT

750 °C



-25 +60 °C



70 °C

STANDARDS/APPROVALS

