

For boards LxH (mm)	200x254	For boards	44 CEP
Type of material	Galvanized metal	Electrocod	1320

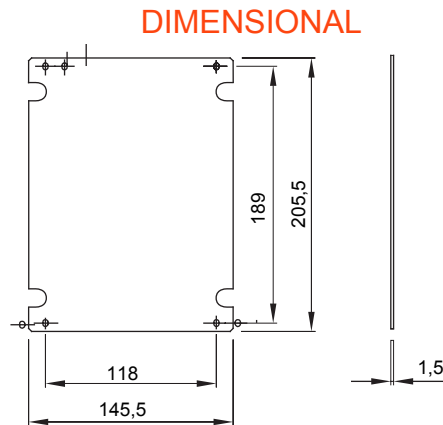

STANDARDS/APPROVALS

