



70 RT HP is a complete offer of rotary isolator switches from 16 A to 160 A, available in boxes both in insulating material and metal, in control or emergency versions, compatible with the main applications for residential, tertiary and industrial contexts.  
 DC versions for photovoltaic applications are also available from 16 A to 40 A in insulating box.  
 The series is completed with versions for board from 16 A to 1000 A and for DIN rail fixing from 16 A to 63 A, which can be equipped with auxiliary contacts.  
 The devices have been designed to reduce wiring time, facilitate installation and guarantee the maximum safety and robustness even in the most demanding conditions.

Circuit breaker	Rotary isolator	Version	Box
Material	Insulation	Type	For emergency
Rated current (A)	125	No. of poles	3P+N
Knob colour	Red	Lockable	YES (max. 3 locks in OFF)
IP degree	IP66/IP67/IP69	Mechanical resistance	IK08
Ambient temperature	-25 +60 °C	Lid screws (no. and type)	4 insulation
Current in AC21A (415V)	125	Current in AC22A (415V)	125
Type of accessory	Max. 4 auxiliary contacts (2 per side)	Current in AC23A (415V)	125
Cable section	4-70 mm <sup>2</sup>		

#### BEHAVIOUR WITH CHEMICAL AND ATMOSPHERIC AGENTS

Saline solution	Acids		Bases		Solvents				Mineral oil	UV rays
	Concentrated	Diluted	Concentrated	Diluted	Hexane	Benzol	Acetone	Ethyl alcohol		
Resistant	Limited resistance	Resistant	Not resistant	Limited resistance	Limited resistance	Not resistant	Not resistant	Limited resistance	Resistant	Resistant

#### DIMENSIONAL

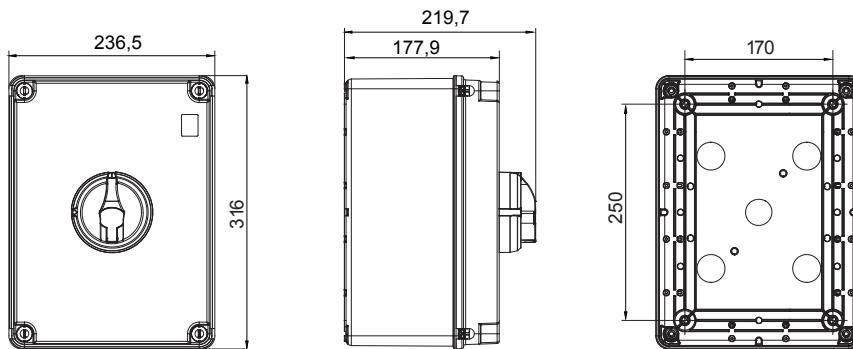

#### TECHNICAL SYMBOLOGY

**IP**      **IK**

IP66/IP67/IP69

IK08

#### STANDARDS/APPROVALS

