



70 RT HP is a complete offer of rotary isolator switches from 16 A to 160 A, available in boxes both in insulating material and metal, in control or emergency versions, compatible with the main applications for residential, tertiary and industrial contexts. DC versions for photovoltaic applications are also available from 16 A to 40 A in insulating box. The series is completed with versions for board from 16 A to 1000 A and for DIN rail fixing from 16 A to 63 A, which can be equipped with auxiliary contacts. The devices have been designed to reduce wiring time, facilitate installation and guarantee the maximum safety and robustness even in the most demanding conditions.

Circuit breaker	Rotary isolator	Version	Box
Material	Insulation	Type	Command
Rated current (A)	25	No. of poles	4P
Knob colour	Black	Lockable	YES (max. 3 locks in ON and OFF)
IP degree	IP66/IP67/IP69	Mechanical resistance	IK08
Ambient temperature	-25 +60 °C	Lid screws (no. and type)	4 insul. 1/4 turn
Current in AC21A (415V)	25	Holes entry	2 x M20/25 + 2 x M20/25
Current in AC22A (415V)	25	Type of accessory	Max. 2 auxiliary contacts (1 per side)
Current in AC23A (415V)	25	Cable section	1-10 mm ²

BEHAVIOUR WITH CHEMICAL AND ATMOSPHERIC AGENTS

Saline solution	Acids		Bases		Solvents				Mineral oil	UV rays
	Concentrated	Diluted	Concentrated	Diluted	Hexane	Benzol	Acetone	Ethyl alcohol		
Resistant	Limited resistance	Resistant	Not resistant	Limited resistance	Limited resistance	Not resistant	Not resistant	Limited resistance	Resistant	Resistant

DIMENSIONAL

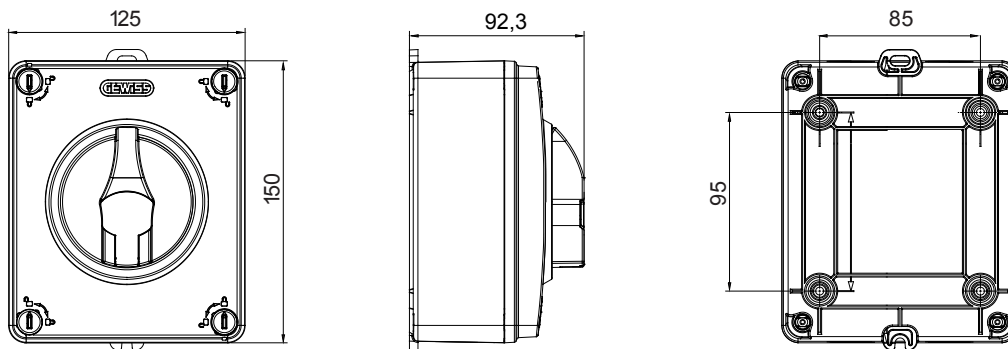

TECHNICAL SYMBOLOGY

IP **IK**

IP66/IP67/IP69

IK08

STANDARDS/APPROVALS

