



70 RT HP is a complete offer of rotary isolator switches from 16 A to 160 A, available in boxes both in insulating material and metal, in control or emergency versions, compatible with the main applications for residential, tertiary and industrial contexts.

DC versions for photovoltaic applications are also available from 16 A to 40 A in insulating box.

The series is completed with versions for board from 16 A to 1000 A and for DIN rail fixing from 16 A to 63 A, which can be equipped with auxiliary contacts.

The devices have been designed to reduce wiring time, facilitate installation and guarantee the maximum safety and robustness even in the most demanding conditions.

Circuit breaker	Rotary isolator	Version	For board
Rated current (A)	250	No. of poles	3P
Regulation field	124 - 244 mm	No. of modules EN 50022	9
Current in AC21A (415V)	250	Knob colour	Black
Current in AC22A (415V)	250	Lockable	YES (max. 3 locks in OFF)
Current in AC23A (415V)	250	Cable section	70-185 mm ²
Power dissipation per pole	6,5 W/pole		

DIMENSIONAL

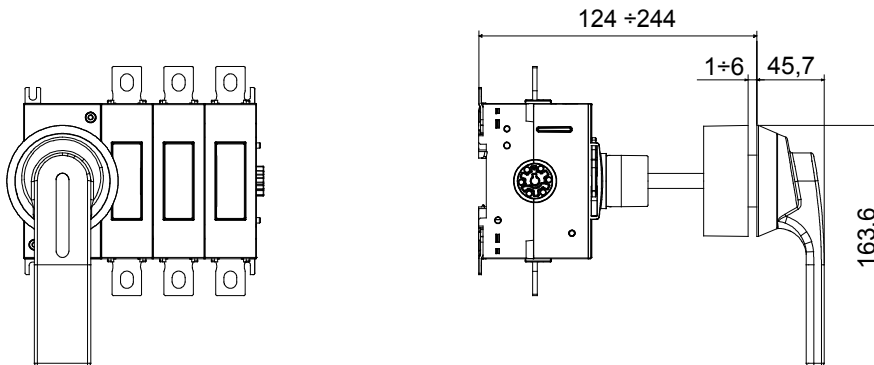

STANDARDS/APPROVALS

