



Industrial-type socket-outlets conforming to IEC 309 Standard, with mechanical interlock consisting of a circuit breaker enabling the plug to be connected and disconnected only in the open position, and the switch to close only with the plug inserted. Wide range including models with rotary switch and fuseholder base, AUTOMATIKA with 6kA C characteristic miniature circuit breaker, and version with safety transformer. High application versatility thanks to the possibility of assembly in back-mounting and flush-mounting boxes, and boards of the 68 Q-DIN and Q-MC ranges.

Type	Horizontal	Fuse breaking capacity	> 50 kA
Thermo-pressure with ball	125 °C (active parts) - 80 °C (passive parts)	IP degree	IP44
No. of poles	3P+E	Mechanical resistance	IK08
Frequency	50/60 Hz	Operating temperature	-25 +40 °C
Protection	Fuse-holder base (CBF)	With back-mounting box	Yes
Electrocod	2220	Glow wire test	850 °C (active parts) - 650 °C (passive parts)
Colour	Yellow	Rated current (A)	32
Reference h	4	Rated voltage	100-130 V
Fuses holder	E18		

#### BEHAVIOUR WITH CHEMICAL AND ATMOSPHERIC AGENTS

Saline solution	Acids		Bases		Solvents				Mineral oil	UV rays
	Concentrated	Diluted	Concentrated	Diluted	Hexane	Benzol	Acetone	Alcohol		
Resistant	Not resistant	Limited resistance	Limited resistance	Limited resistance	Limited resistance	Not resistant	Not resistant	Limited resistance	Limited resistance	Resistant

#### DIMENSIONAL

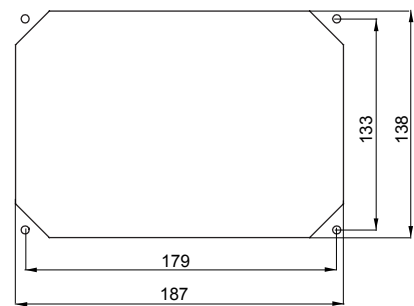

#### TECHNICAL SYMBOLOGY

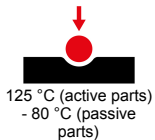

**IP**  
IP44

**IK**  
IK08



**GWT**

850 °C (active parts)  
- 650 °C (passive parts)

#### STANDARDS/APPROVALS

