

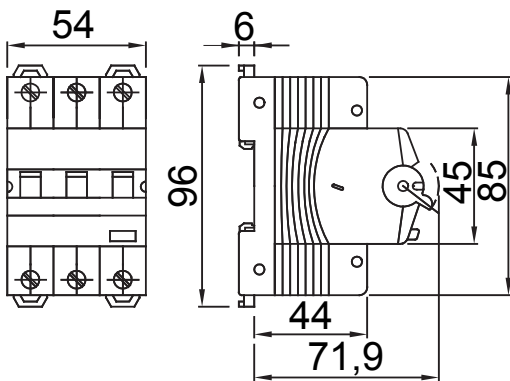

Description	RCCB WITH OVERCURRENT PROTECTION
Code	MDC 100
No. of poles	3P
No. modules	3
Rated current	10 A
Rated residual operating current	30 mA
Type	A
Curve	C
Rated voltage (IEC/EN 61009-1, 61009-2-1)	230/240 V
Energy limiting class	3

Standard	IEC/EN 61009-1, IEC/EN 61009-2-1	Rated frequency (Hz)	50/60 Hz
Breaking capacity IEC/EN 61009-1 230V (Icn)	10000 A	Breaking capacity IEC/EN 61009-1 400V (Icn)	10000 A
Breaking capacity IEC/EN 61009-1 (Ics)	0.75 x Icn	Breaking capacity IEC/EN 60947-2 230V (Icu)	15 kA
Breaking capacity IEC/EN 60947-2 (Ics)	50% Icu	Insulation voltage (Ui)	500 V
Level of immunity (8/20 μs)	250 A	Rated impulse withstand voltage (Uimp)	4 kV
Overvoltage category	III	Electrical endurance	10.000
Mechanical endurance	20.000	Section rigid cable	<=1x35 - <=2x16 - <=1x16+2x10 mm ²
Section flexible cable	<=1x35 - <=2x16 - <=1x16+2x10 mm ²	Double connection	YES (only down stream)
Rated tightening torque	2 Nm	Operating temperature	-25 +60° C (derating of In with T>30° C)
Stocking temperature	-40 +70 °C	Auxiliaries compatibility	Yes
Assembly position	Any		

DIMENSIONAL



WIRING DIAGRAM



STANDARDS/APPROVALS

