



SMART [PRO]e 1M is a medium-power outdoor and indoor LED floodlight, ideal for lighting small to medium-sized areas and sports facilities. It can be installed on the wall, ceiling or ground thanks to the galvanised steel bracket which is powder coated in polyester with trivalent passivation and equipped with an adjustable goniometric scale and supplied in kit form. The main body is made in die cast aluminium EN AB 46100, with an integrated passive heat sink, and powder coated polyester frame with trivalent passivation. COB LED technology for high efficacy. Reflector made of metallised PC-HT or anodised and polished aluminium. 4mm thick toughened front glass, silkscreen printed for symmetrical versions or with anti-reflective nanocoating for asymmetrical versions. Anti-ageing silicone gaskets and A2 stainless steel exterior screws. Plastic venting and anti-condensation device. Electrical connection via 5x1mm² H07RN-F cable. Insulation Class 1. Built-in 1-10V dimmable driver. Available with five different types of optics, three types of Correlated Colour Temperature (3000K/4000K/5700K) and two different types of Colour Rendering Index (CRI70, CRI80). Designed to withstand surges up to 6KV (differential mode) and 10KV (common mode), temperature variations from -30°C to +40°C, water and dust penetration up to IP66, and impact up to IK08.

GENEL BİLGİLER

Bağlam	Floodlighting and small- to medium-size sports facilities
armatür panoları	LED luminaire with mid lumen power İç / Dış
Benzersiz dijital kod (Datamatrix)	Şu anda mevcut değil
Renk	Grafit grisi
Işık kaynağı tipi	LED - değiştirilemez
Sistem gücü	150 W
LED Ömrü	L90B10 (Tq+25°C) = 100000h; L80B10 (Tq+25°C) > 150000h
Ağırlık (kg)	5.7
Garanti	5 yıl
Depolama sıcaklığı	-
Çalışma sıcaklığı	-30 +40 °C
MATERYALLER	
Gövde	Alüminyum pres döküm
Ekran tipi	Anti-reflective super-transparent 4 mm thick surface glass
Optik	Polished anodised aluminium reflector with 99.99% pure aluminium
Conta	Yaşlanma karşıtı silikon
Kilitleme Kancası	-
Dış vida	Paslanmaz çelik
Renk	Polyester powder coated with epoxy base coat
STANDARTLAR VE ONAYLAR	
Sınıflandırma	-
Yüzey sıcaklığı azaltılmış cihaz	-
DIN 18032-3 belgesi	Uyumlu
IPEA	-
Yalıtım sınıfı	I
IP derecesi	IP66
Direnç dayanıklı	IK08

OPTİK VE AYDINLATICI ÖZELLİKLER

Optik	ALW - Asimetrik Orta
Birleştirilmiş Parlama Derecelendirmesi	G*6 - ULOR = 0%
Lümen çıkışı (lm)	19500
Efficacy (lm/W)	130
Renk Sıcaklık	5700 K
Colour Rendering Index	CRI>80
Standart Sapma Renk Eşleştirme	SDCM = 3
Fotobiyolojik Risk Sınıfı	RG1
Standart	EN60598-1; EN60598-2-5; IEC62778; EN13201
ELETRİK VE AYDINLATMA ÖZELLİKLERİ	
besleme voltaj	220 - 240V
Nominal frekans (Hz)	50 / 60
sürücü	Dahil
Sürücü arıza oranı	F10 = 100.000h Tq25°C
aşırı gerilim koruması	DM 6 kV / CM 10 kV
Kontrol sistemi	Satnd alone - 1/10V
KURULUM VE BAKIM	
Mounting and installation	Yüksek direkli aydınlatma - Duvara montaj - Yere montaj
Eğim	Entegre gonyometreli braket üzerinde dönüş
kablolama	With H07RN-F multi-pole cable
çin	Braket
Işık kaynağı değiştirilebilirliği	Profesyonel olarak
Kontrol tertibatı değiştirilebilirliği	-
Sürücü Kutusu	Yerleşik
Rüzgara maruz maksimum yüzey	0,085 m ²

DIMENSIONAL

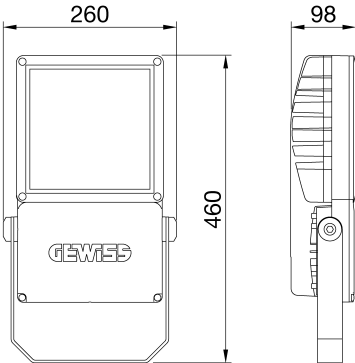

PHOTOMETRIC DISTRIBUTION

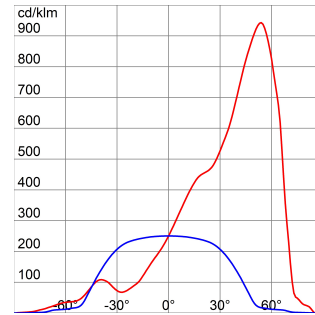

Smart [PRO]e

TECHNICAL SYMBOLOGY



IP
IP66

IK
IK08

STANDARDS/APPROVALS

