

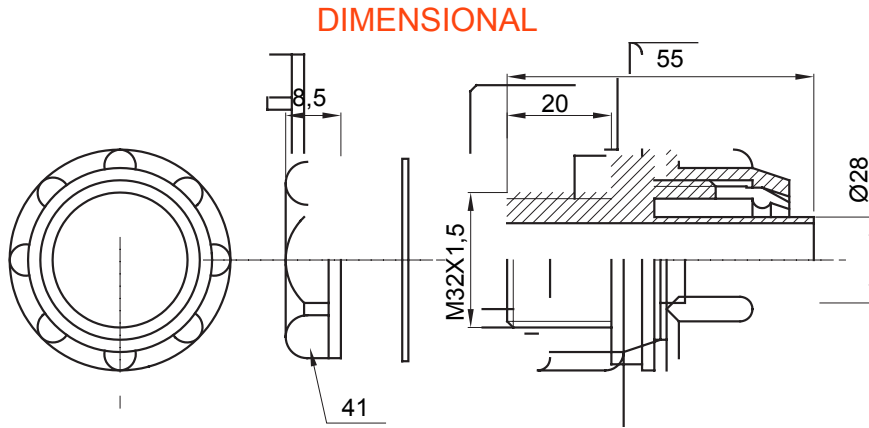

IP54 koruma sınıfına sahip kılıf için düz ve döner bağlantı cihazı.

Renk	Gri RAL 7035	IP derecesi	IP54
ISO aralık	M32x1.5	Kılıf Ø (mm)	28
Tip	Sabit	Elektrokod	210



### TECHNICAL SYMBOLOGY

**IP**

IP54

### STANDARDS/APPROVALS

