

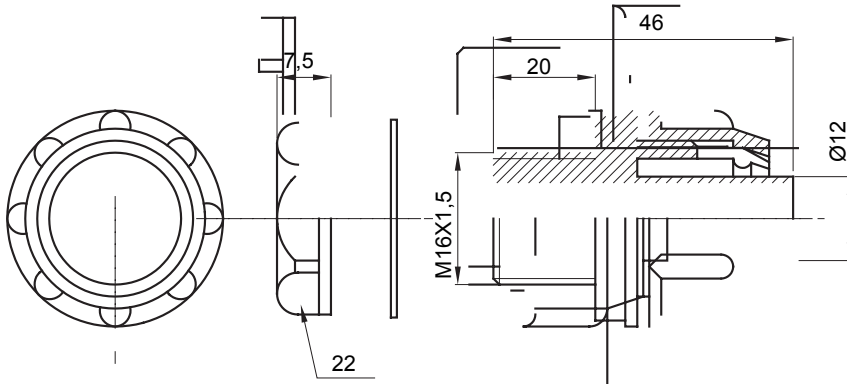

IP54 koruma sınıfına sahip kılıf için düz ve döner bağlantı cihazı.

Renk	Gri RAL 7035	IP derecesi	IP54
ISO aralık	M16x1.5	Kılıf Ø (mm)	12
Tip	Sabit	Elektrokod	210

DIMENSIONAL



TECHNICAL SYMBOLOGY

IP

IP54

STANDARDS/APPROVALS

