

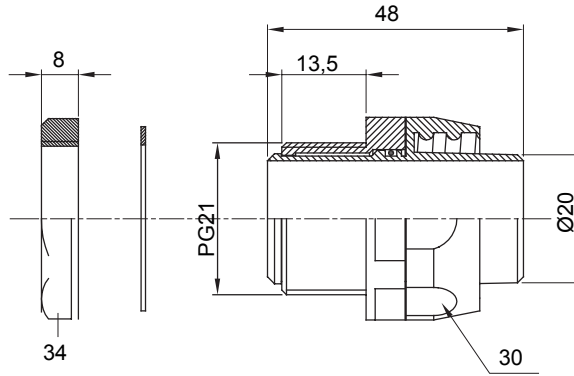

IP54 koruma sınıfına sahip kılıf için düz ve döner bağlantı cihazı.

Renk	Siyah RAL 9005	IP derecesi	IP54
PG aralık	21	Kılıf Ø (mm)	20
Tip	Döner	Elektrokod	210

DIMENSIONAL



TECHNICAL SYMBOLOGY

IP

IP54

STANDARDS/APPROVALS

