

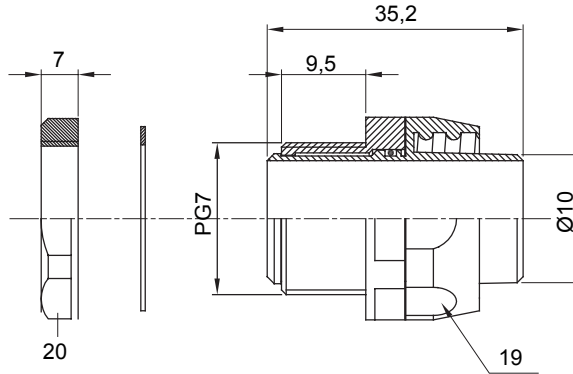

IP54 koruma sınıfına sahip kılıf için düz ve döner bağlantı cihazı.

Renk	Gri RAL 7035	IP derecesi	IP54
PG aralık	7	Kılıf Ø (mm)	10
Tip	Döner	Elektrokod	210

DIMENSIONAL



TECHNICAL SYMBOLOGY

IP

IP54

STANDARDS/APPROVALS

