

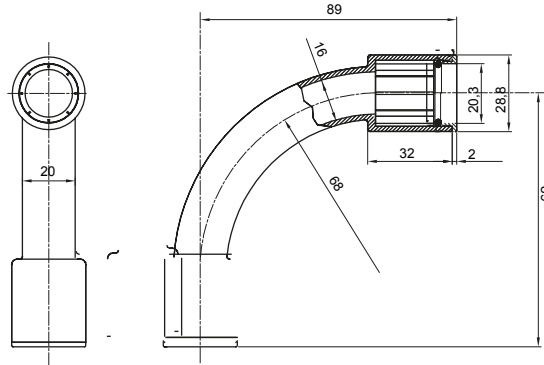

IP40 ve IP67 koruma sınıfına sahip rijit koruyucu borular için yönlendirme bileşenleri.

Renk	Gri RAL 7035	IP derecesi	IP67
Borular Ø (mm)	20	Malzeme tipi	EN 60754-2 uyarınca halojen Free dir
Elektrokod	21221		

### DIMENSIONAL



### TECHNICAL SYMBOLOGY

IP

HF  
HALOGEN FREE

IP67

### STANDARDS/APPROVALS

