

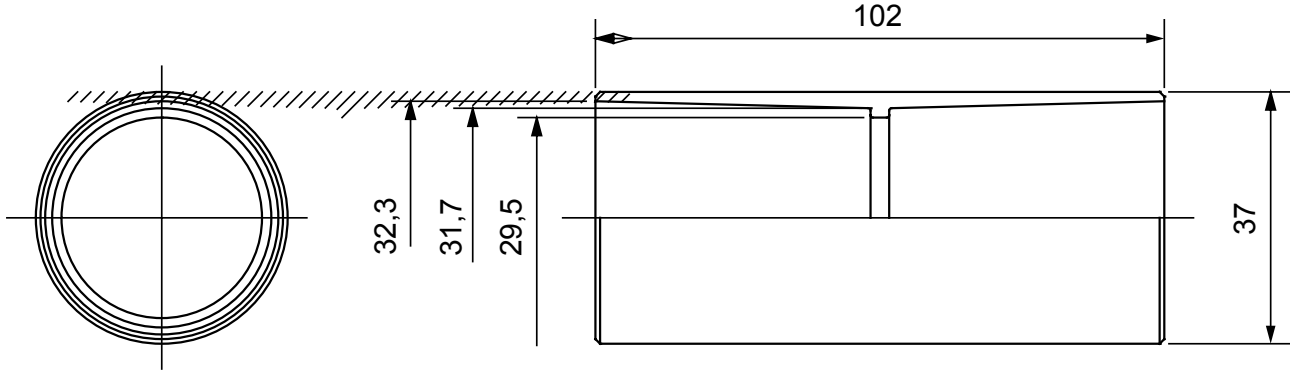

IP40 ve IP67 koruma sınıfına sahip rijit koruyucu borular için yönlendirme bileşenleri.

Renk	Gri RAL 7035	IP derecesi	IP40
Borular Ø (mm)	32	Malzeme tipi	EN 60754-2 uyarınca halojen Free dir
Elektrokod	21221		

DIMENSIONAL



TECHNICAL SYMBOLOGY

IP

HF
HALOGEN FREE

IP40

STANDARDS/APPROVALS

