

The System modular devices make it possible to create infinite combination between devices and plates, thanks to a complete range that is able to satisfy all design, functional and installation requirements. Colour and finiture: glossy white, bright and versatile  
Ideal for flush-mounting solutions (for rectangular or square boxes), surface-mounting solutions, and for special applications. The range includes commands, socket- outlets, protection, indicators, connectors and devices for the control, safety and comfort of your home.

Tanım	2P+T - 10A	Renk	Beyaz
Voltaj	250 V ac	Toprak yuvası	-
Standart	Avustralyalı	Özellikler	-
Fiş pinleri için	Düz	Standart	IEC 60884-1; AS/NZS 3112
Test voltajındaki rezistans	1 dak. için 2000 V a 50 Hz	Uzatılmış kullanım (konum değişiklikleri sayısı)	10.000, 250 V ac $\cos\phi=0,8$
Bilyeli termo sıcaklık	125 °C	Akkor Tel Deneyi:	850 °C
Kablo çekmede terminal tutuşu	> 50 N	Terminal sıkıştırma kapasitesi esnek kablolar (mm <sup>2</sup> )	min. 0,75 - maks. 2x4
Terminal sıkıştırma kapasitesi sert kablolar (mm <sup>2</sup> )	min. 0,5 - maks. 2x2,5	SYSTEM modül sayısı	2
Malzeme	Teknopolimer	Elektrokod	0131

#### DIMENSIONAL

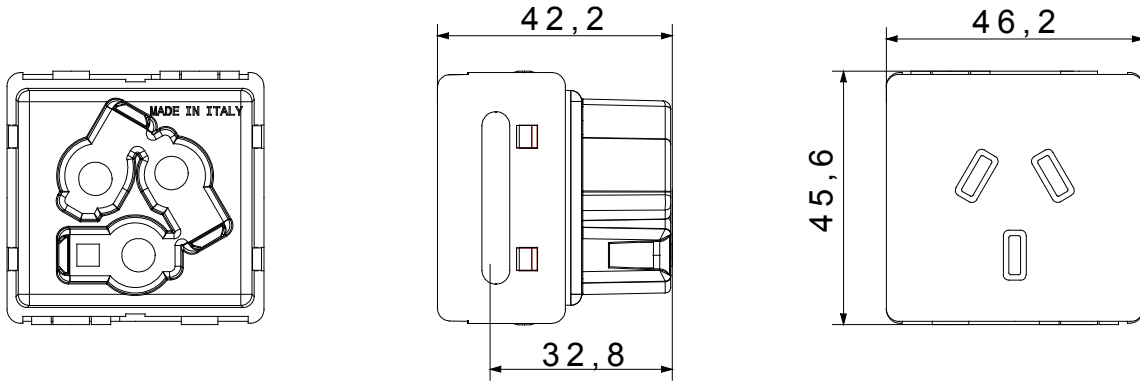

#### TECHNICAL SYMBOLOGY



#### STANDARDS/APPROVALS

