

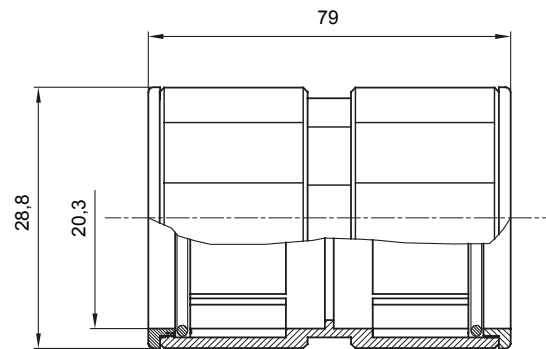

Componente de rutare pentru conducte de protecție rigide cu grad de protecție IP40 și IP67.

Culoare	Gri RAL 7035	Grad IP	IP67
Conducte Ø (mm)	20	Tip material	Fără halogeni în conformitate cu EN 60754-2
Electrocod	21221		

DIMENSIONAL

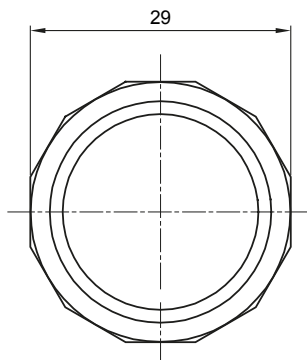

TECHNICAL SYMBOLOGY

IP

HF
HALOGEN FREE

IP67

STANDARDS/APPROVALS

