

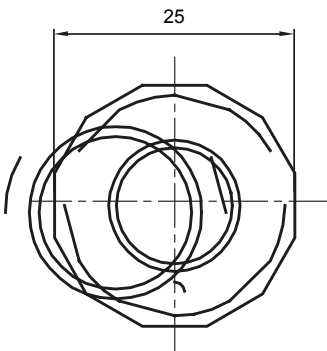

Componente de rutare pentru conducte de protecție rigide cu grad de protecție IP40 și IP67.

Culoare	Gri RAL 7035	Grad IP	IP65
Conducte Ø (mm)	16	Manta Ø (mm)	12
Tip material	Fără halogeni în conformitate cu EN 60754-2	Electrocod	21221

DIMENSIONAL



TECHNICAL SYMBOLOGY

IP

HF
HALOGEN FREE

IP65

STANDARDS/APPROVALS

