

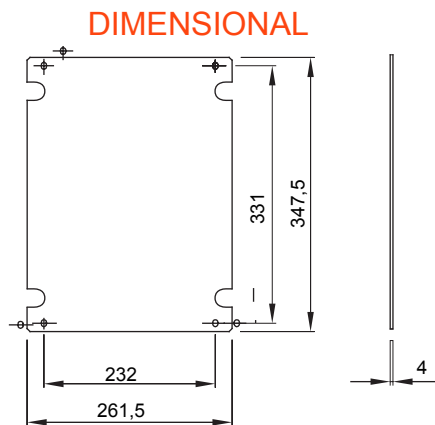

Pentru plăci LxH (mm)	316x396	Pentru plăci	44 CEP
Tip material	Izolație	Electrocod	1320



STANDARDS/APPROVALS

