

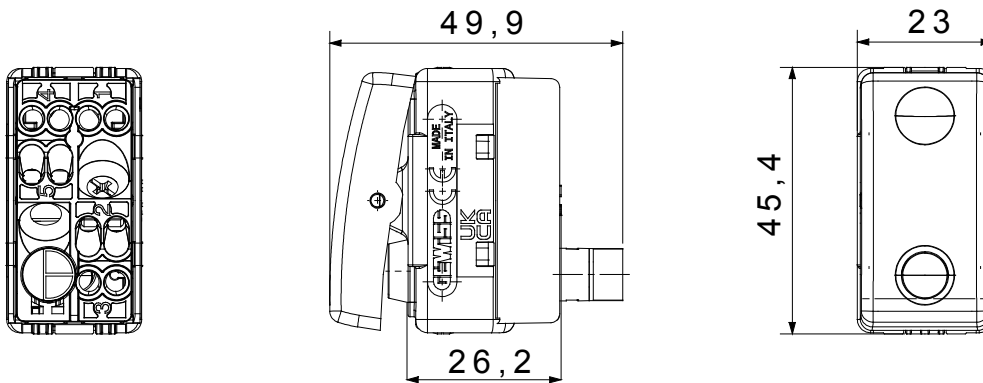

The System modular devices make it possible to create infinite combination between devices and plates, thanks to a complete range that is able to satisfy all design, functional and installation requirements. Colour and finiture: glossy white, bright and versatile
Ideal for flush-mounting solutions (for rectangular or square boxes), surface-mounting solutions, and for special applications. The range includes commands, socket-outlets, protection, indicators, connectors and devices for the control, safety and comfort of your home.

Categorie	Comutator cu o cale	Butonul automat	Cu lentilă neutră înlocuibilă
Simbol	-	Culoare	Alb
Descriere	2P - 16 AX iluminat DIN spate	Tensiune	250 V
Unitate de semnalizare	Miniature lamp - Fluorescent - 230Vac - 0,4W - Red	Standard	EN 60669-1
Rezistența la tensiunea de test	2000 V la 50 Hz timp de 1 minut	Puterea nominală a lămpilor cu LED 230V	200 W
Rezistența izolației	>5 MOhm	Borne de cablare	Conținut
Comutator de funcționare prelungit (nr. de moduri de funcționare)	1000000 c.a. cosφ=0,6	Termo-presiune cu bilă	125 °C
Test de încercare cu fir incandescent	850 °C	Prinderea bornei la tracțiunea cablului	> 50 N
Capacitate de strângere borne cabluri torsadate (mm ²)	min. 0,75 - max. 2x4	Capacitate de strângere a bornelor cabluri solide (mm ²)	min. 0,5 - max. 2x2,5
Nr. Module DE SISTEM	1	Material	Tehnopolimer
Electrocod	0130		

DIMENSIONAL



TECHNICAL SYMBOLOGY



STANDARDS/APPROVALS

