

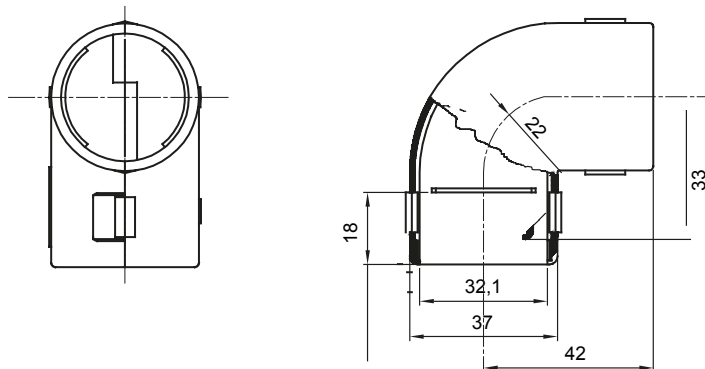

Nyomvonalai alkatrészek IP40 és IP67 védelemmel rendelkező merev védőcsövekhez.

Szín	Szürke RAL 7035	IP védelem szintje	IP40
Védőcső Ø (mm)	32	Elektronikai kód	21221

DIMENSIONAL



TECHNICAL SYMBOLOGY

IP

IP40

STANDARDS/APPROVALS

