

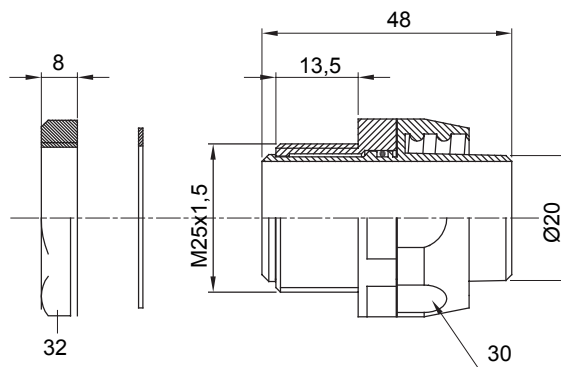

Raccord tournant droit pour gaine avec degré de protection IP54.

Couleur	Gris RAL 7035	Indice de protection	IP54
Pas métrique	M 25x1,5	Gaine Ø (mm)	20
Type de filetage	M25	Type	Tournant
Electrocod	210		

DIMENSIONS



SYMBOLE TECHNIQUE

IP

IP54

NORMES ET HOMOLOGATIONS

