



Description Interruttore non automatico scatolato
Code MSXM 1600
Nombre de pôles 4P
Courant nominal 1600 A
Déclencheur -

ELECTRICAL CHARACTERISTICS

Norme	IEC/EN 60947-2
Catégorie d'utilisation	AC-23A, DC-22A
Fréquence nominale (Hz)	50 / 60
Rated operating voltage (Ue)	690 Vac - 250 Vdc
Tension nominale tenue à l'impulsion (Uimp)	8 kV
Catégorie de surtension	IV
Tension d'isolement (Ui)	800 V
Thermal regulation	-
Magnetic regulation	-
Neutral protection	-
Total power loss	225.28 W
Rated short-circuit current making capacity (Icm)	45
Rated short-time withstand current for 0,3s (Icw)	20 kA
I _{dn} regulation	-
DT regulation	-

SERVICE BREAKING CAPACITY (ICU)

220/240Vac
400/415Vac
440Vac
525Vac
690Vac
250Vdc

MECHANICAL CHARACTERISTICS

Exécution	Fixe
DIN rail mounting	Non
Accessoriabile con comando motore	Si
Compatible interlock	A filo (meccanismo in dotazione)
Terminals supplied	RC arrière
Position de montage	Tout
Upline/downline power supply	Si
Electrical life (415Vac)	2.000 cycles
Mechanical life	5.000 cycles
Température d'utilisation	-5°C +65°C
Température de stockage	-20° +65°
Poids (kg)	32.9
Largeur	280 mm
Hauteur	370 mm
Profondeur	140 mm

RATED BREAKING CAPACITY (ICS)

220/240Vac	-
400/415Vac	-
440Vac	-
525Vac	-
690Vac	-
250Vdc	-

DIMENSIONS

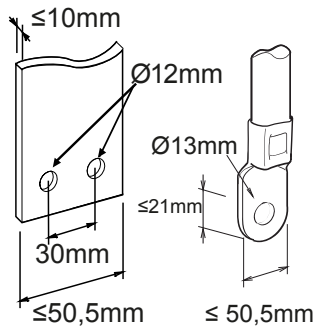



Fiche produit
GWD9458B

Gamme MSX

NORMES ET HOMOLOGATIONS

