

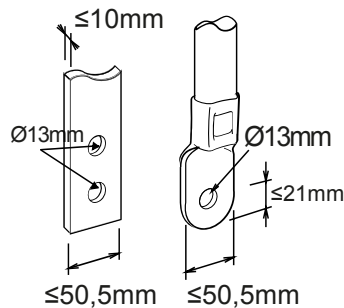

Description Interruttore automatico scatolato
Code MSXE 1600
Nombre de pôles 4P
Courant nominal 1600 A
Déclencheur Électronique

ELECTRICAL CHARACTERISTICS		MECHANICAL CHARACTERISTICS	
Norme	IEC/EN 60947-2	Exécution	Fixe
Catégorie d'utilisation	B	DIN rail mounting	Non
Fréquence nominale (Hz)	50 / 60	Accessoriabile con comando motore	Si
Rated operating voltage (Ue)	690 Vac	Compatible interlock	A filo (meccanismo in dotazione)
Tension nominale tenue à l'impulsion (Uimp)	8 kV	Terminals supplied	FB avant étendu
Catégorie de surtension	IV	Position de montage	Tout
Tension d'isolement (Ui)	800 V	Upline/downline power supply	Si
Thermal regulation	0,4 - 0,5 - 0,63 - 0,8 - 0,9 - 0,95 - 1 x In	Electrical life (415Vac)	2.000 cycles
Magnetic regulation	Electronic LSI	Mechanical life	5.000 cycles
Neutral protection	50% - 100% x Ir	Température d'utilisation	-5°C +65°C
Total power loss	225.28 W	Température de stockage	-20° +65°
Rated short-circuit current making capacity (Icm)	-	Poids (kg)	35
Rated short-time withstand current for 0,3s (Icw)	20 kA	Largeur	280 mm
I _{dn} regulation	-	Hauteur	370 mm
DT regulation	-	Profondeur	140 mm
SERVICE BREAKING CAPACITY (ICU)		RATED BREAKING CAPACITY (ICS)	
220/240Vac	85 kA	220/240Vac	65 kA
400/415Vac	50 kA	400/415Vac	38 kA
440Vac	45 kA	440Vac	34 kA
525Vac	30 kA	525Vac	23 kA
690Vac	20 kA	690Vac	15 kA
250Vdc	-	250Vdc	-

DIMENSIONS





Fiche produit
GWD9425B

Gamme MSX

NORMES ET HOMOLOGATIONS

