

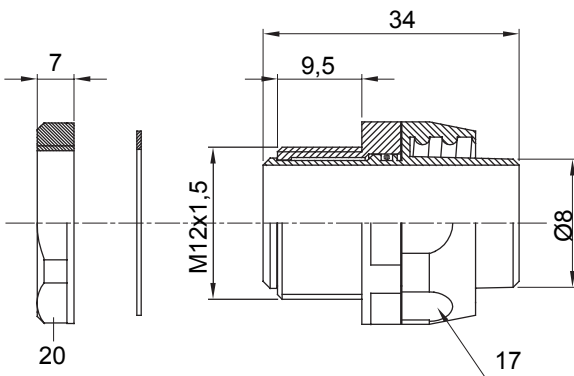

Racores de vaina rectos y giratorios con grado de protección IP54.

Color	Negro RAL 9005	Grado de protección	IP54
Paso métrico	M 12x1,5	Vaina Ø (mm)	8
Tipo	Giratorio	Código Electrocod	210

DIMENSIONAL



SIMBOLOGÍA TÉCNICA

IP

IP54

MARCAS/APROBACIONES

