

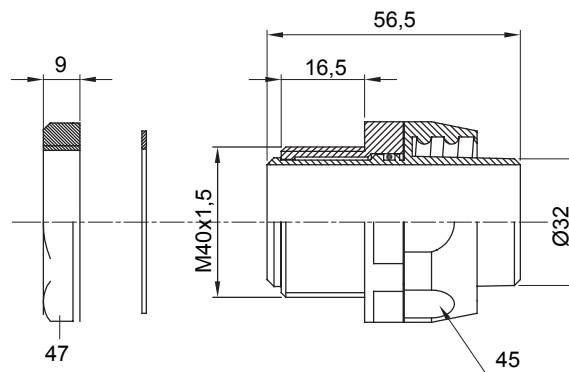

Racores de vaina rectos y giratorios con grado de protección IP54.

Color	Negro RAL 9005	Grado de protección	IP54
Paso métrico	M 40x1,5	Vaina Ø (mm)	32
Tipo	Giratorio	Código Electrocod	210

### DIMENSIONAL



### SIMBOLOGÍA TÉCNICA

**IP**

IP54

### MARCAS/APROBACIONES

