

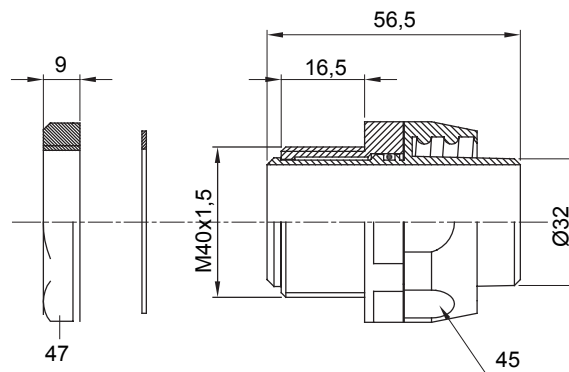

Raccord tournant droit pour gaine avec degré de protection IP54.

Couleur	Gris RAL 7035	Indice de protection	IP54
Pas métrique	M 40x1,5	Gaine Ø (mm)	32
Type de filetage	M40	Type	Tournant
Electrocod	210		

### DIMENSIONS



### SYMBOLE TECHNIQUE

**IP**

IP54

### NORMES ET HOMOLOGATIONS

