

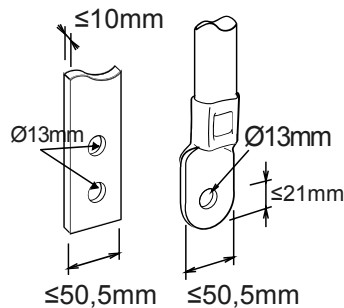

Description Interruttore non automatico scatolato
Code MSXM 1250
Nombre de pôles 4P
Courant nominal 1250 A
Déclencheur -

ELECTRICAL CHARACTERISTICS		MECHANICAL CHARACTERISTICS	
Norme	IEC/EN 60947-2	Exécution	Fixe
Catégorie d'utilisation	AC-23A, DC-22A	DIN rail mounting	Non
Fréquence nominale (Hz)	50 / 60	Accessoriabile con comando motore	Si
Rated operating voltage (Ue)	690 Vac - 250 Vdc	Compatible interlock	A filo (meccanismo in dotazione)
Tension nominale tenue à l'impulsion (Uimp)	8 kV	Terminals supplied	RC arrière
Catégorie de surtension	IV	Position de montage	Tout
Tension d'isolement (Ui)	800 V	Upline/downline power supply	Si
Thermal regulation	-	Electrical life (415Vac)	4.000 cycles
Magnetic regulation	-	Mechanical life	5.000 cycles
Neutral protection	-	Température d'utilisation	-5°C +65°C
Total power loss	281.24 W	Température de stockage	-20° +65°
Rated short-circuit current making capacity (Icm)	32	Poids (kg)	23.4
Rated short-time withstand current for 0,3s (Icw)	15 kA	Largeur	280 mm
I _{dn} regulation	-	Hauteur	370 mm
DT regulation	-	Profondeur	120 mm
SERVICE BREAKING CAPACITY (ICU)		RATED BREAKING CAPACITY (ICS)	
220/240Vac	-	220/240Vac	-
400/415Vac	-	400/415Vac	-
440Vac	-	440Vac	-
525Vac	-	525Vac	-
690Vac	-	690Vac	-
250Vdc	-	250Vdc	-

DIMENSIONS





Fiche produit
GWD9460B

Gamme MSX

NORMES ET HOMOLOGATIONS

