

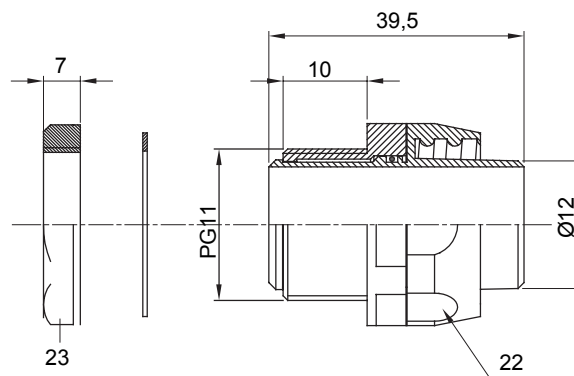

Raccord tournant droit pour gaine avec degré de protection IP54.

Couleur	Gris RAL 7035	Indice de protection	IP54
Pas PG	11	Gaine Ø (mm)	12
Type de filetage	PG11	Type	Tournant
Electrocod	210		

### DIMENSIONS



### SYMBOLE TECHNIQUE

**IP**

IP54

### NORMES ET HOMOLOGATIONS

