

GENERAL INFORMATION		OPTIC AND ILLUMINATING FEATURES	
Context	Interior lighting	Optic	Wide opal
Luminaire	LED luminaire for diffuse light	Unified Glare Rating	-
Application	Internal	Lumen output (lm)	3600
Unique digital code (Datamatrix)	Currently not present	Efficacy (lm/W)	103
Colour	White	Colour temperature	4000 K
Type of light source	LED	Colour Rendering Index	CRI 80
System power	35 W	Standard Deviation Colour Matching	SDCM = 3
LED Lifetime	L80B50 (Tq25°) = 50.000h	Photobiological Risk Class	RG0
Weight (kg)	0.8	Standard	EN 60598-1; EN 60598-2-2; IEC/TR 62778; EN 62493
Warranty	5 years	ELETRICAL AND LIGHTING FEATURES	
Stocking temperature	-20° +65°	Supply voltage	220-240 V
Operating temperature	-20° +45°	Rated frequency (Hz)	50 / 60
MATERIALS		Driver	External - Included
Body	Die-cast aluminium	Driver failure rate	F025 (Tq=25°C) = 50.000 h
Shield type	Polycarbonate	Overvoltage protection	DM 1 kV
Optic	Opalescent polycarbonate diffuser	Control System	ON / OFF
Gasket	-	INSTALLATION AND MAINTENANCE	
Locking Hook	-	Mounting and installation	For flush-mounting
External screw	-	Tilt	-
Colour	Powder coating	Wiring	With connection terminal on driver
STANDARDS AND APPROVALS		Fixing	Via springs integrated with the luminaire
Classification	-	Light souce replaceability	Non-replaceable
Device with reduced surface temperature	-	Controlgear replaceability	By professional
DIN 18032-3 certification	Not available	Driver Box	-
IPEA	-	Maximum surface exposed to the wind	-
Insulation class	II	-	-
IP degree	IP40 - IP54	-	-
Mechanical resistance	IK06	-	-
Glow Wire Test	650 °C	-	-

DIMENSIONAL

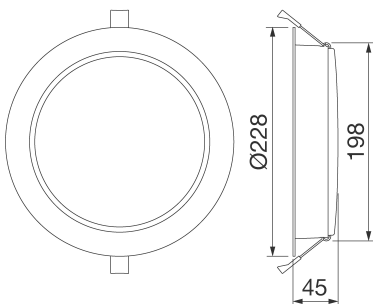

PHOTOMETRIC DISTRIBUTION

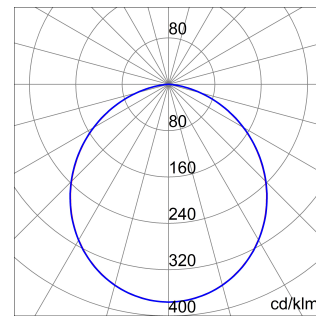

TECHNICAL SYMBOLOGY



IP
IP40 - IP54

IK
IK06

GWT
650 °C

STANDARDS/APPROVALS



Data, measures, designs and pictures are for information purpose only, last update 28/04/2024. They can be changed at any moment, therefore it is always recommended to read the last updated version published on the website www.gewiss.com. Lumen output and system power are subject to a tolerance of +/- 10%. Unless stated otherwise, the values apply to an ambient temperature of 25°C. Terms of warranty at <https://www.gewiss.com/it/en/company/landingpage/led-warranty>. - 1 of 1