



Systems of accessories for electrical installations used for residential, tertiary and industrial applications. The system consists of fasteners for pipes and cables, cable fittings, accessories for rigid pipes (RK Series) and flexible conduit (DF Series). The system include also a wide variety of cable ties (52FS Range) and terminal blocks (44 Range).

Colour	Grey RAL 7035	Material	Shockproof polymer
For external conduits (mm)	20	Mounting hole Ø (mm)	23
IP with rigid conduit	IP66	IP with corrugated conduit	IP54
Glow Wire Test	750 °C	Operating temperature	-5 +60 °C
Electrocod	21221	Standard	EN 61386-1 - EN 60670-1 (as applicable)

#### BEHAVIOUR WITH CHEMICAL AND ATMOSPHERIC AGENTS

Saline solution	Acids		Bases		Solvents				Mineral oil	UV rays
	Concentrated	Diluted	Concentrated	Diluted	Hexane	Benzol	Acetone	Ethyl alcohol		
Resistant	Limited resistance	Limited resistance	Resistant	Resistant	Resistant	Resistant	Resistant	Resistant	Resistant	Limited resistance

#### DIMENSIONAL

PG 16

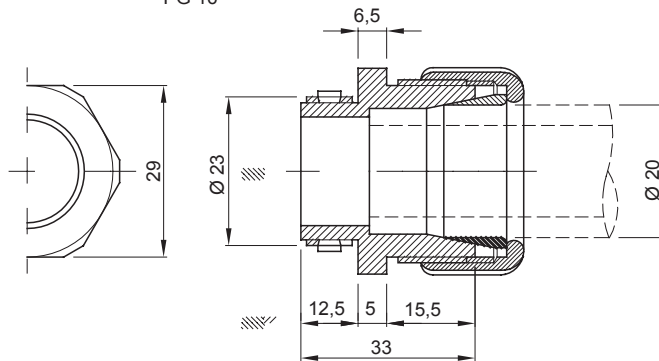

#### TECHNICAL SYMBOLOGY

**GWT**

750 °C

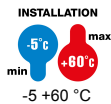

-5 +60 °C

#### STANDARDS/APPROVALS

