

Colour	Transparent	Material	PVC
Conduits Ø (mm)	50	Electrocod	210

DIMENSIONAL

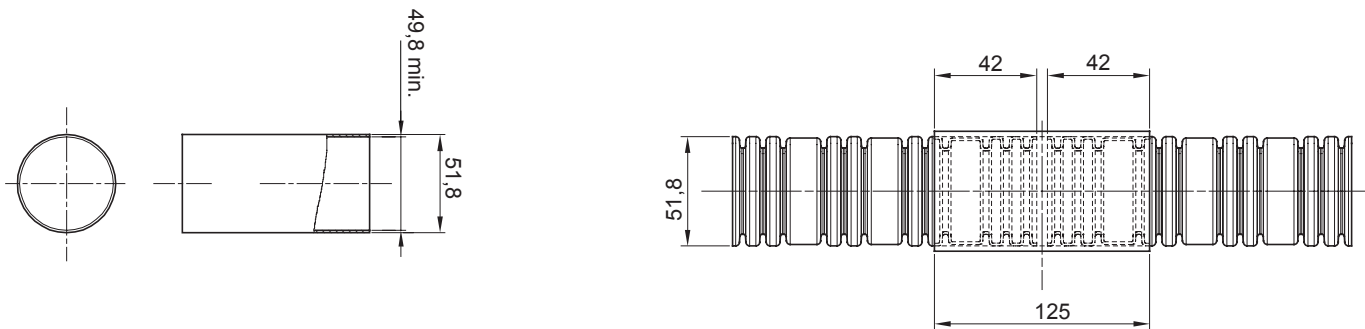

STANDARDS/APPROVALS

