

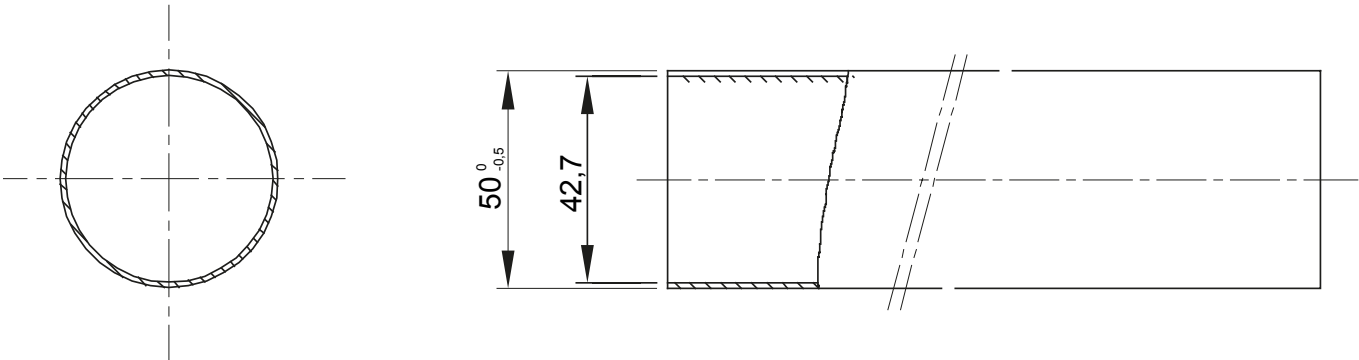

Rigid heavy protected conduit system range RKB made in thermoplastic PVC material, classification 4321. In compliance with IEC 61386-1 (CEI 23/80) e IEC 61386-21 (CEI 23/81). The range includes conduit system available in 7 diameter, from 16 to 63 mm for length 3 metres. Suitable for electrical systems and/or data transmission. Installation type: exposed on walls and ceilings or for applications inside false ceilings and floating floors.

Colour	Grey RAL 7035	Material	PVC
Length (m)	3	Conduits Ø (mm)	50
Glow Wire Test	960 °C	Electrocod	21220
Resistance to compression	4 (Heavy - 1250 N)	Resistance to impact	3 (Medium - 2 J)
Resistance to bending	1 (Rigid)	Electrical characteristics	2 (With electrical insulating characteristics)
Protection against ingress of solid objects without accessories	0	Protection against ingress of water objects without accessories	0
Resistance against corrosion	Not applicable to plastic conduit systems	Fire resistance	1 (Non-flame propagating)
Insulation resistance	100 MΩ a 500V for 1 minute	Protection against ingress of solid objects with accessories	4/6 (It depends on the accessories used)
Protection against ingress of water with accessories	0/5/7 (It depends on the accessories used)	Dielectric rigidity	2000 V a 50 Hz for 15 minutes
Standard	EN 61386-1 EN 61386-21	Family	RKB
Classification	4321		

DIMENSIONAL



TECHNICAL SYMBOLOGY

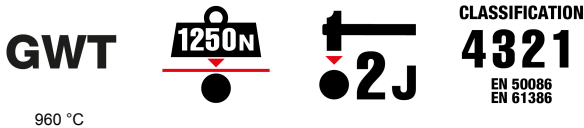

STANDARDS/APPROVALS

