



Range of Watertight surface-mounting boards made stainless steel material. In compliance with IEC 61439-1 (CEI 17/113), IEC 61439-2 (CEI 17/114), IEC 60670-1 (CEI 23/48), IEC 60670-24 (CEI 23/49) e IEC 62208 (CEI 17-87). Available in 3 sizes, transparent and black door versions with IP55 protection degree. Fast&Easy accessories, made in metal, allow the installation of modular devices and moulded-case circuit breakers up to 250A into the boards, reducing assembly times by up to 40%. Indicated for automation and distribution for indoor applications, in areas that are frequently cleaned with water jets.

Insulation class	Pre-arranged with earth terminal	Nominal dim. LxHxD (mm)	405x650x200
IP degree	IP55	Material	Stainless steel from 10/10 to 15/10 (e.g. AISI 304)
Mechanical resistance	IK10	No. locks	2
No. of modules EN 50022	72 (18x4)	Application	For indoor use, in areas that are frequently cleaned with water jets
Dispersible power A (W)	135	Dispersible power B (W)	97
Functional dim. LxHxD (mm)	405x650x200	Operating temperature	-25 +60 °C
Type of material	Stainless steel	Electrocod	0320
Standard	EN 61439-1, EN 61439-2, EN62208, EN 60670-1, IEC 60670-24	Family	46 QX
Maximum rated insulation voltage (Ui)	690 V	Type of door	Blank door

#### BEHAVIOUR WITH CHEMICAL AND ATMOSPHERIC AGENTS

Saline solution	Acids		Bases		Solvents				Mineral oil	UV rays
	Concentrated	Diluted	Concentrated	Diluted	Hexane	Benzol	Acetone	Ethyl alcohol		
Limited resistance	Not resistant	Limited resistance	Limited resistance	Limited resistance	Resistant	Resistant	Resistant	Resistant	Resistant	Resistant

#### DIMENSIONAL

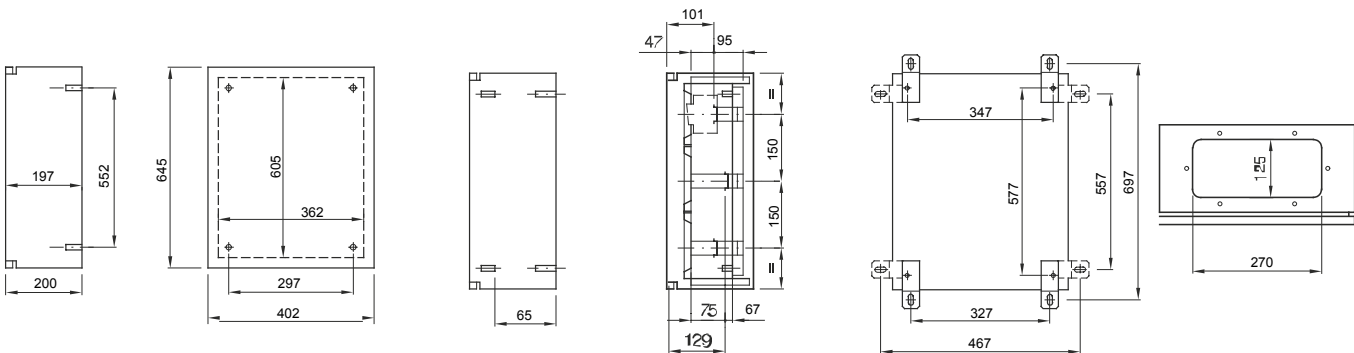

#### TECHNICAL SYMBOLOGY

**IP**

IP55

**IK**

IK10



-25 +60 °C

#### STANDARDS/APPROVALS

