



Description Interruttore non automatico scatolato
 Code MSXM 1600
 No. of poles 4P
 Rated current 1600 A
 Release -

ELECTRICAL CHARACTERISTICS

Standard	IEC/EN 60947-2	Execution	Fixed
Use category	AC-23A, DC-22A	DIN rail mounting	No
Rated frequency (Hz)	50 / 60	Accessorabile con comando motore	Si
Rated operating voltage (Ue)	690 Vac - 250 Vdc	Compatible interlock	-
Rated impulse withstand voltage (Uimp)	8 kV	Terminals supplied	Front FB Extended
Overvoltage category	IV	Assembly position	Any
Insulation voltage (Ui)	800 V	Upline/downline power supply	Si
Thermal regulation	-	Electrical life (415Vac)	2.000 cycles
Magnetic regulation	-	Mechanical life	5.000 cycles
Neutral protection	-	Operating temperature	-5°C +65°C
Total power loss	225.28 W	Stocking temperature	-20° +65°
Rated short-circuit current making capacity (Icm)	45	Weight (kg)	32.9
Rated short-time withstand current for 0,3s (Icw)	20 kA	Width	280 mm
I _{dn} regulation	-	Height	370 mm
DT regulation	-	Depth	140 mm

SERVICE BREAKING CAPACITY (ICU)

220/240Vac	-	220/240Vac	-
400/415Vac	-	400/415Vac	-
440Vac	-	440Vac	-
525Vac	-	525Vac	-
690Vac	-	690Vac	-
250Vdc	-	250Vdc	-

DIMENSIONAL

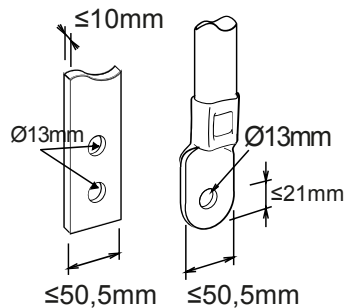



Product Data Sheet

GWD9456

MSX Range

STANDARDS/APPROVALS

