

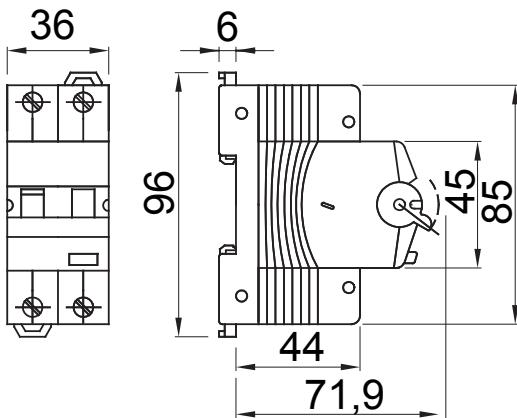

| | |
|---|----------------------------------|
| Description | RCCB WITH OVERCURRENT PROTECTION |
| Code | MDC 100 |
| No. of poles | 1P+N |
| No. modules | 2 |
| Rated current | 10 A |
| Rated residual operating current | 30 mA |
| Type | AC |
| Curve | C |
| Rated voltage (IEC/EN 61009-1, 61009-2-1) | 230/240 V |

| | | | |
|---|---|--|---|
| Standard | IEC/EN 61009-1, IEC/EN 61009-2-1 | Rated frequency (Hz) | 50/60 Hz |
| Breaking capacity IEC/EN 61009-1 230V (Icn) | 10000 A | Breaking capacity IEC/EN 61009-1 (Ics) | 0.75 x Icn |
| Breaking capacity IEC/EN 60947-2 230V (Icu) | 10 kA | Breaking capacity IEC/EN 60947-2 (Ics) | 75% Icu |
| Insulation voltage (Ui) | 500 V | Level of immunity (8/20 μs) | 250 A |
| Rated impulse withstand voltage (Uimp) | 4 kV | Overvoltage category | III |
| Electrical endurance | 10.000 | Mechanical endurance | 20.000 |
| Section rigid cable | <=1x35 - <=2x16 - <=1x16+2x10 mm ² | Section flexible cable | <=1x35 - <=2x16 - <=1x16+2x10 mm ² |
| Double connection | YES (only down stream) | Rated tightening torque | 2 Nm |
| Operating temperature | -25 +40 °C | Stocking temperature | -40 +70 °C |
| Auxiliaries compatibility | Yes | ReStart compatibility | Yes |
| Assembly position | Any | | |

DIMENSIONAL



WIRING DIAGRAM

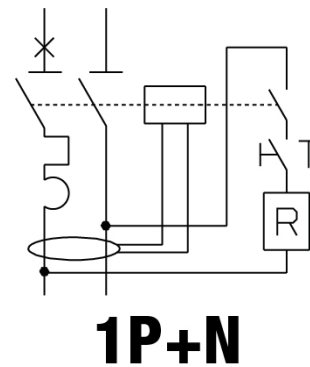

STANDARDS/APPROVALS

