

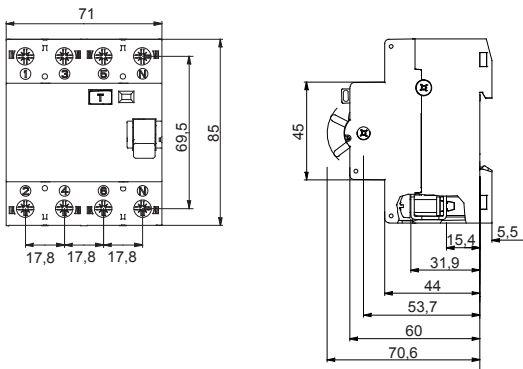

Description	RESIDUAL CURRENT CIRCUIT BREAKER
Code	IDP
No. of poles	4P
No. modules	4
Rated current	125 A
Rated residual operating current	30 mA
Type	A
Rated voltage (EN/IEC 61008-1, 61008-2-1)	400V

Standard	IEC/EN 61008-1, IEC/EN 61008-2-1	Rated frequency (Hz)	50Hz
Insulation voltage (Ui)	400 V	Rated impulse withstand voltage (Uimp)	4 kV
Overvoltage category	III	Level of immunity (8/20 μs)	200 A
Section rigid cable	≤ 50 mm ²	Section flexible cable	≤ 50 mm ²
Rated tightening torque	2.5 Nm	Double connection	YES (up stream and down stream)
Operating temperature	-25 +40 °C	Stocking temperature	-35 +60 °C
Electrical endurance	4000	Mechanical endurance	10.000
Auxiliaries compatibility	Yes	ReStart compatibility	No
Assembly position	Any		

DIMENSIONAL



WIRING DIAGRAM

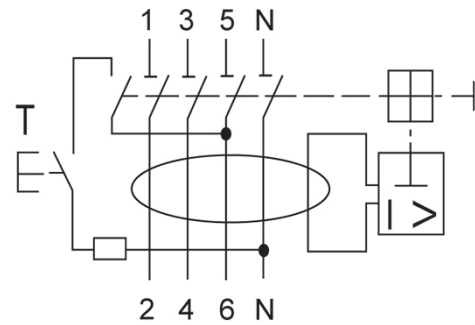

STANDARDS/APPROVALS

